

DEFEND THE TERRITORY!

**TACTICS AND TECHNIQUES FOR COUNTERING
POLICE ASSAULTS ON INDIGENOUS COMMUNITIES**



WARRIOR PUBLICATIONS

DEFEND THE TERRITORY!

Contents

Introduction	2
Personal Security & Surveillance	3
Personal Protective Clothing and Equipment	3
Mask and Uniform	3
Protective Gear for Chemical Agents	4
*First Aid for chemical agents	4
Protective Gear against Blunt Trauma Wounds	5
*First Aid for blunt trauma wounds	6
Know Your Enemy: Police Crowd Control	
Tactics and Weapons	7
Tactics and Formations	7
Riot cop protective gear	8
Chemical Agents	8
1. Pepper Spray / OC	8
2. Tear Gas	8
Less-Lethal Launchers	9
Less-Lethal Ammunition	11
Lethal Weapons / Firearms	12
Other Police Weapons	12
Taser	13
Armoured Vehicles	14
Defence against armoured vehicles	18
Water Cannons	18
Blockades	19
State Repression of Blockades	21
Notes from "Shut the province down"	22
Notes from US Army Counter-Mobility Operations manual	23

INTRODUCTION

Communities that are effective in carrying out resistance will inevitably face some form of state repression, most often carried out by police forces. This text is intended as a review of tactics and techniques that have been used in countering police assaults on crowds and communities.

For police, these types of assaults are referred to as "public order" or "crowd control" operations. Communities targeted by such operations may face riot cops as well as armed tactical units, dog teams, armoured vehicles, the use of chemical agents and baton charges.

Native peoples in Canada have seen the deployment of police crowd control units on numerous occasions since the 1980s. Some notable examples include Listiguj/Restigouche in 1981, Kahnawake 1988, Kanesatake and Kahnawake 1990, Ipperwash 1995, Six Nations 2006, Barriere Lake 2008 and 2012, and most recently in Rexton, New Brunswick, in October 2013.

The most common target for police crowd control operations against Native peoples are blockades. This is because the blockade is highly effective as a form of direct action taken by communities defending their land and people.

While Native peoples in North America have a recent history of armed resistance (including Wounded Knee 1973, Oka 1990, and Ts'Peten 1995), most communities do not typically engage in such actions. Most, however, do have the capability of carrying out blockades and other similar types of low-level direct actions. As corporations and government continue to relentlessly exploit and destroy the natural world, it is highly likely that such actions will increase in frequency in the future as communities act to defend themselves and their land.

Warrior Publications, Spring 2014

WarriorPublications.wordpress.com

Copy and Distribute this publication! It is 24 8x11 inch pages in total.

Personal Security & Surveillance



Masked warriors at Kanesatake (Oka), 2004.

We live in a high-tech society in which we are always vulnerable to surveillance. By using basic security measures, we can limit the abilities of police and intelligence agencies to gather information.

Security is especially important for warriors who will be targeted by police during any defensive actions and who may face criminal charges for defending their land and people.

For more info, see *Security & Counter-Surveillance Manual*, by Warrior Publications, 2014 edition.

Internet: The Internet is a main source of intelligence for police. Posting your intentions on Facebook or other social media will help police identify you, track you, disrupt your activities, and/or create a pool of suspects present during an action. Cops also troll social media for photos and videos to use in investigations.

Cell/Smart phones: Cell phones can function as tracking devices through the cellular network, enabling police to track your movements. Some phones also have built in GPS that are even easier to track. Spyware can be covertly downloaded into cell phones, turning them into listening devices even when turned off. If you carry a cell phone during an action, and particularly when any sensitive discussions are occurring (such as planning or strategy, etc.), the battery should be removed. Some also advocate the phone itself be kept away from an area in which sensitive information is being discussed. Unless you need a cell phone for vital communications work, it may be best to leave it at home when participating in a defensive action.

Identity: The identities of warriors should be concealed during defensive actions. The main methods for doing this are by using code-names and wearing uniform clothing and masks.

Personal Protective Clothing and Equipment

Mask and Uniform

Warriors often wear a mask and uniform clothing to conceal their identity during an action.

The most common uniforms worn are combat fatigues, usually in the US Woodland camouflage pattern. But wearing drab and non-distinct civilian clothing with masks can also work (as in Kanesatake 2004).

The more uniform the clothing is among a group, the more difficult it can be for police to identify individuals.

A common tactic is to wear civilian clothing under an outer layer of clothing that can be quickly removed if it is necessary to escape a police containment (for example).

Masks are among the most controversial items of clothing worn by protesters and warriors alike. Police and politicians hate them because it makes it difficult to do surveillance of a crowd & identify individuals. Some reformists and pacifists demonize the mask as it threatens their media image. Nevertheless, masks are an important tactic for warriors that serve an essential defensive role.

The most effective mask covers the entire head, such as a balaclava or ski mask. Bandanas tied around the back of the head can become loose and slip down. *A bandana over just the lower face is not an effective disguise.*

When putting on masks and clothing it is important to do so in a location that is not under surveillance, otherwise police may gain photos of individuals as they are preparing. This could then be used in court as a means of identifying a masked individual.

Masks and Legality

In 2013, new legislation was introduced in Canada criminalizing masks worn during an unlawful assembly or riot. A gathering must first be declared an “unlawful assembly” or a “riot” before people wearing masks can be arrested and charged. The new law, entitled the *Preventing Persons from Concealing Their Identities During Riots and Unlawful Assemblies Act*, carries a maximum 5 year sentence for wearing a mask during an unlawful assembly, and 10 years for wearing one during a riot.

Despite this, it is not “illegal” to wear a mask during a protest, defensive action, or any public gathering. The only other criminal charge related to masking is *Disguise with intent* (part of Section 351 of the criminal code). Under this law, it must be proven that an individual had the intent to commit a specific criminal act (such as burglary).



Tyendinaga Mohawks, 2008.

Protective Gear for Chemical Agents

A minimum defence against chemical agents is the use of eye goggles and a covering over the nose and mouth (such as a bandana or mask). This is greatly improved with a filter mask in place of the bandana. The most effective protection against chemical agents is a military issue gas mask.

Goggles: Goggles vary from those used in swimming to skiing goggles or workshop type eye protection goggles. Swimming goggles and other types that form a tight barrier around the eyes, thereby keeping out chemical agents, also have a tendency to fog up. Those with small air holes along the side and top rim fog up less, but can allow small droplets of chemical agents into the eye area.



Bandana: Improvised protection against tear gas has included goggles (the type that seal around the eyes and have no small air holes) along with a bandana soaked in apple-cider vinegar. The bandana can be carried in Zip-loc bags until needed. A bottle of apple-cider vinegar should be carried in a group, as the bandana can become dried out. Any piece of suitably sized cloth can be used in place of a bandana.

Filter mask: These are usually half face masks that cover the nose and mouth, with filters that can be replaced. They can be acquired from hardware and industrial supply stores, for uses such as aerosol painting, renovations, or jobs producing large amounts of dust. An average cost is \$25. A recommended mask is the 3M half mask filter with a P100 filter (P100 is a recommended rating for CS, CN, and OC chemical agents). Goggles must be worn with a half face mask to protect the eyes.

Full face mask versions are also available, although more expensive.

Gas mask: The best type of protection against chemical agents is a full-face gas mask, such as those found in military surplus stores or industrial supply stores. Common military gas masks available include



the Canadian Forces issued C4 version (no longer in production), as well as Israeli civilian gas masks. Prices are usually around \$50 or more for a military gas mask in surplus stores.

First Aid for chemical agents

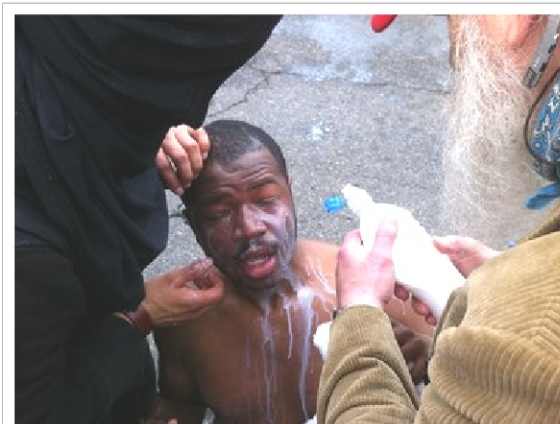

Eye/face wash: The most common and readily available treatment for chemical agents is flushing the eyes and face with water. A water bottle with a small cap and which is squeezable is recommended, as this produces a stronger stream of water. When flushing the eyes, the head should be tilted to the side so that contaminated water can flow off the face.

Street medics often use a diluted liquid antacid solution, usually *Maalox*. The mix is half water, half *Maalox*. It is placed in a squeezable bottle, and used in the same way as water.

Along with the eyes, it is also important to wash off any chemical agents that has landed on exposed skin. Failure to do so can result in blistering of the skin.

Sudecon is a decontamination wipe produced by Fox Labs (who also make pepper spray), often used by police and paramedics for CS, CN, and OC agents. It comes in a small foil pouch and opens to a towelette 8 X 12 inches in size. The manufacturer recommends two wipes be used per casualty, and claims to enable recovery after 7 to 15 minutes. A *Sudecon* wipe costs approx. \$2 each.

Vexor produces an OC First Aid towelette that is similar to *Sudecon*.

Fresh air: The casualty should be removed from the area if possible, and preferably placed in a cool, windy location.

Decontamination: Any contaminated clothing and gear should be removed as soon as practical and placed in a garbage bag. Contaminated clothing can later be cleaned in a washing machine, while packs etc., can be scrubbed with soapy water. If this is not done, wherever the casualty and/or their gear goes will become contaminated with the chemical agent (such as vehicles, rooms, tents, etc). If possible, the casualty should also shower as soon as possible to remove chemical agents from the skin and hair.

Protective Gear against Blunt Trauma Wounds



.Skateboarding and motorcycle helmet (full face version).

Helmets: Hockey, skateboarding, bicycle, and motorcycle helmets can be worn to protect against baton strikes or projectiles. Motorcycle helmets with face guards can prevent the wearing of a gas mask. Helmets can have distinctive logos removed and be spray painted a uniform colour.

Gloves: Leather gloves are preferred to protect the hand from hot objects, such as tear gas canisters (which are often picked up and thrown back into police lines).

Body Armour: Sports gear for hockey, lacrosse, or motocross type body armour, such as shin guards, forearm protectors, as well as chest protectors and shoulder pads. Smaller shin guards can be used for forearm protectors. Armour that has good foam padding and a hard plastic outer is preferred.



Motocross upper body armour

Foam padding, such as those used in sleeping pads (closed cell foam), cut into shape and held in place with duct tape. Close cell padding can be used for legs, lower and upper arms, as well as chest protectors.



Knee and shin guards made of hard plastic; light improvised upper body armour from foam cell padding.

Shields: There are two types of shields: individual shields and shield walls.

Individual shields are often improvised from hard plastic or plywood. Large round plastic traffic pylons have been used, cut in half to create two rounded shields. Small sections of plywood have also been used. On both hard plastic and plywood shields, carrying handles are usually attached to the interior (secured with bolts or a rope that has been tied through and

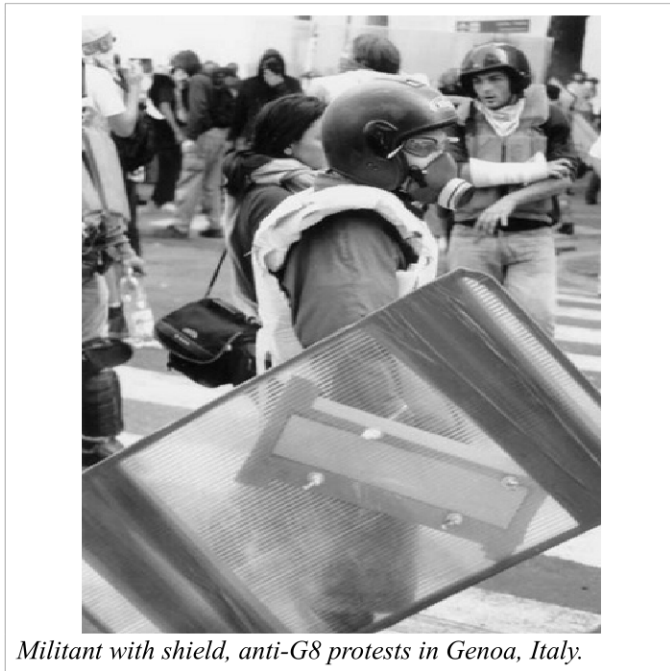

Militant with shield, anti-G8 protests in Genoa, Italy.

knotted on each side).

Many police shields are made of *Lexan*, a brand of polycarbonate. Lexan sheets can be acquired from hardware stores such as Home Depot (approx. \$150 for a 36 X 72 inch



Squatters in Brazil with shields, helmets and batons. The shields appear to be cut from large, heavy duty, plastic water barrels, with eye slots and rope handles attached.

sheet). A cheaper but less durable alternative is Plexiglass.

In some mobilizations, protesters have designed shields that also function as protest signs. In one student strike, students made shields in the form of large books.

Shield walls have been most commonly seen in Italy. Large sheets of clear plexiglass type material have been used. Some are built with wood frames and have wheels attached to aid in moving them.

The shield wall enables protesters to approach a police line without fear of police firing projectiles, and then to begin pushing the police back (but this relies on having enough mass to counter that of the police line). Shield walls are vulnerable to flank attacks, when cops begin assaulting shield wall carriers from the sides.

Another type of shield wall seen is that of a section of galvanized sheet metal, carried at the front of a crowd.



Shield wall on march in Italy.

Reinforced banners

Banners by themselves can communicate a message and also be used to block police surveillance cameras. Reinforced banners function as a type of shield in that they may reduce the impact of projectiles and also provide some protection against baton strikes. They are mostly used to push up against police lines, where the possibility of baton strikes is greatest. Reinforced banners can also deter snatch squads (see below in police tactics section) and can be used to break through police lines if necessary. They are usually constructed with large banners, perhaps ten feet wide or more, made of heavy material such as canvas or vinyl, attached to a reinforced frame. The frame, made of wood, or a ladder, for example, helps carry the banner and provides protection against baton strikes when held to the front.

First Aid for blunt trauma wounds

Bruising and swelling

The most common injuries are painful bruising and swelling, which can be treated using the acronym RICE, which stands for Rest, Ice, Compression, and Elevate:

Rest: Both the casualty and the injured area should get rest. An injured limb should not be used.

Ice: Apply a cold pack (such as a bag of frozen vegetables, or ice-cubes wrapped in a towel, or an actual cold pack). A cold packs reduces pain and swelling. Apply for 20 minutes and let the area rewarm for 30 minutes, then reapply.

Compress: Applying a snug but not overly tight compress to the injured area can also help reduce swelling and pain. Elastic bandages are commonly used, but a towel or shirt can also be used. A compress should be checked to ensure it does not restrict circulation.

Elevate: elevate the injured part above the heart, if possible, as this will also help reduce swelling and pain.

Bleeding

Cuts and lacerations can also occur from baton strikes or projectiles.

Apply pressure: The first step in treating any external bleeding is to apply pressure to the wound. This stems the flow of blood and enables clotting to begin.

Immediate pressure can be applied with the casualties hand (if capable) or the first aider's hand. Pressure can also be applied using a clean towel or shirt. Once the bleeding is controlled, maintain pressure with sterile dressing and bandages (or, a clean t-shirt, etc.). If dressing become blood soaked, do not remove them as this may disturb blood clots, instead, apply new dressings over top.

Rest: The casualty should rest to slow the flow of blood.

BASIC GEAR LIST



Whether or not you wear a mask and uniform clothing, the following pieces of equipment should be carried in any confrontational action, blockade, etc.

- A medium sized backpack to carry tools and equipment, including protective gear.
- A water bottle for hydration as well as first aid for chemical agents.
- Gloves to keep your hands warm and limit forensic evidence (fingerprints). Leather gloves are preferred so you can handle hot items from a camp fire or pick up a tear gas grenade.
- Energy bars or other high energy snacks (i.e., pemmican or dried fish, dried berries, etc.).
- Rain gear, such as a jacket & pants or a poncho, protect you from wind and rain as well as chemical agents.

Know Your Enemy: Police Crowd Control Tactics and Weapons



RCMP Tactical Troop in "hard tac" with helmets & shields. They are in a typical line formation.

The "Riot Cops"

Riot cops are usually referred to as crowd control units or public order units. The RCMP refer to their riot cops as Tactical Troops, while many other police call their riot cops Public Safety Units. These are police officers who, in addition to their regular duties, are also on call to respond to crowd control situations. They receive additional training in crowd control tactics, unit formations, etc., and are issued protective gear such as helmets, shields, gas masks, etc.

It is standard practise for crowd control units to deploy with other police units, primarily armed tactical units (such as Emergency Response Teams), dog teams, medics, and video surveillance teams. Armed tactical units are usually responsible for firing less-lethal and lethal weaponry, and operating any armoured vehicles used.

Tactics and Formations

Line formation: This is the most common formation used by riot cops, usually across streets or roadways. It is used to block entry to an area, or to stop the advance of a crowd. The line can be comprised of one row of police, or multiple roles. If multiple rows, the front rank will be shifted to the rear, and the second rank shifted to the front. This allows cops to rest before being put into the front line again.

Snatch squads: Snatch squads are small groups of cops that rush into a crowd and grab a targeted individual, who is then dragged back behind the

police line for arrest and removal. A snatch squad with 4 cops, for example, might have two who grab the target and two who provide security against the crowd.

Arresting cops in a snatch squad do not carry shields. Snatch squads can sometimes be observed preparing, positioning themselves in a line, and/or pointing out targeted individuals.

Kettle / Containment: A kettle is a police tactic in which a crowd is completely surrounded or boxed in by police. It is used to capture large groups of protesters, to prevent them from marching, and for mass arrests. In some cases, people are 'kettled' for several hours and then released through checkpoints, at which they must provide ID. During the Toronto G20, several hundred people were kettled for hours during a heavy rain storm.

Indications that police may attempt to kettle a group are police lines at the front, sides and rear. People escape kettles by dispersing before the kettle is established, or at times by breaking through a line of police.

Baton charges: Baton charges are when riot cops charge a crowd and assault people with batons. It is at times preceded by the firing of less-lethal projectiles, including flash-bang rounds and/or chemical agents. Baton charges usually only last 20-30 feet, at which point the cops stop and re-establish their line formation. Some people panic and begin running, but it is better to make an orderly withdrawal and stop at a point just beyond where the cops will stop to re-establish their line.

Surveillance: Crowd control units have police video surveillance teams attached to them to document individuals in a crowd and any "illegal" activities that occur. Police or intelligence agencies may also conduct covert surveillance from nearby houses or buildings, vehicles, etc.

Undercover cops: Police routinely send undercover cops into protests or actions to gather intelligence, often just by listening to protesters or announcements that are made. Undercover cops are also used to identify individuals in crowd and those that carry out "illegal" activities. When attempting to infiltrate a group of masked militants, undercover cops may also wear masks.



Police "kettle" during Toronto G20, June 2010.



Riot cop protective gear

Riot cops have different levels of uniform. A level one is often referred to as “soft tac” or “soft hat.” In this mode, the cops wear a tactical uniform and baseball cap, along with their patrol belt (including pistol, pepper spray, and baton). This presents a less threatening image and is used when their intelligence indicates a low possibility of conflict.

The second level of uniform is referred to as “hard tac” or “hard hat.” In this mode, the cop wears body armour and carries a gas mask, shield, as well as a 3 foot long riot baton. Most police in Canada also wear a fire retardant cover all over top of the body armour. Fire retardant balaclavas may also be worn. Hard tac is worn when cops expect some form of conflict from a crowd.

Often, police first deploy personnel in soft tac, and if the situation escalates send in the hard tac cops (who are on standby in a nearby location, sometimes an underground parking lot, or in vehicles such as buses or vans).

In hard tac, a riot cop can wear up to 100 pounds of gear. While heavily protected, they are slow and cumbersome. On hot summer days, they face the danger of heat exhaustion. Despite their heavy protective gear, riot cops are still injured from projectiles, batons, kicks, and falls. They can also be fatigued by constant movement and running. Their fire retardant coveralls and gear can still be set ablaze if a sufficient fuel load lands on them. Militants have also used paint bombs to obscure shields and visors, limiting the vision of riot cops. Some paint bombs are simply condoms filled with paint.



Riot cops in Bolivia heavily paint-bombed.

Chemical Agents

1. Pepper Spray / OC

Pepper spray contains *capsaicin*, a chemical derived from cayenne, paprika, or chilies. It is also known as *Oleoresin Capsicum*, which is abbreviated as OC. Pepper spray is carried by individual officers on their duty belt, and is sold commercially as a defence against dogs and bears. It is usually encountered as a fine mist spray with a pepper-like taste and sensation. During crowd control situations, cops may carry large canisters that resemble small fire extinguishers.

Method of dispersal: Pepper spray can be released through hand-held aerosol spray canisters or as part of a projectile weapon (usually rubber pellets, which explode on impact and release OC particles). Police must be within 10-15 feet to be effective with aerosol spray, although rubber pellets can be shot up to an effective range of 50 feet or more.

Effects: Pepper spray attacks the mucous membranes (eyes, nose, and mouth). Exposure to pepper spray causes blurring of vision, tearing and closing of eyes, coughing, and difficulty breathing (most often a tightening of the chest). These can occur within seconds of exposure and persist for 20-30 minutes after. The casualty will probably still feel the effects of OC several hours after exposure.

2. Tear Gas

There are two main types of tear gas used: CN and CS. CS, or Chloroacetophenone, was first developed after World War 2, and can be identified by its white smoke and smell of apple blossom. CS type tear gas is a more potent and less toxic

compound synthesized by Corson and Stoughton (from which CS is derived). CS gas can be identified by its white smoke at the point of dispersal and for several seconds after. It has a pepper-like smell and taste.

Method of dispersal:

Both CN and CS can be released from aerosol spray canisters, usually as grenades which can be thrown or fired from a less-lethal launcher or a shotgun (sometimes with a special canister attachment on the end). These canisters, whether thrown or fired, can be extremely hot. Some canisters land and continue to jump around, making it more difficult to grab them and throw them back into the police lines (a common reaction). CN or CS can also be part of rubber pellets or baton rounds, and upon impact their particles are released into the area.

Effects: The main effects of tear gas are pain, burning, and irritation of exposed mucous membranes and skin. The eye is the most sensitive to tear gas and will close involuntarily and begin tearing. This usually causes temporary blindness. Large amounts of saliva and snot are produced, with coughing and a tightening of the chest, leading to an overall inability to breathe properly. These conditions often lead people to panic. On exposed skin, a burning irritation may be felt, and if untreated the skin may begin to blister. Other effects include nausea and vomiting. These effects can be felt within seconds of exposure and persist for 20-30 minutes. The casualty will often still feel some effects several hours after exposure.

Chemical agents are deployed through a wide variety of means:

Hand held canister:

Each cop carries a small canister of OC on his/her duty belt that shoots an aerosol spray. These usually have an effective range of 3-10 feet. Larger canisters used for crowd control usually shoot a liquid stream that delivers a larger payload over a greater distance (with an effective range of 15-20 feet).

Chemical Agent Round:

A projectile that is fired with a fuze delay ignition that, after being launched, usually lands within a crowd and begins dispersing a chemical agent (CN, CS, or OC). The primary purpose of this round is to disperse a crowd. Some versions begin jumping around after landing

while dispersing their payload (to prevent people grabbing them). Chemical agent rounds can be extremely hot and should only be handled with gloves. An effective range for such rounds is 100 metres.



A variety of used tear gas and pepper spray canisters.

Rubber Pellet Chemical Round:

These are rubber pellets that contain a chemical agent inside them which disperses on impact. The round can be fired from shotguns, less-lethal launchers, or pepper ball guns.

Plastic Baton Round with Chemical Agent:

A rubber baton round with a chemical agent payload in its body that is dispersed on impact. The round can be fired from a shotgun or less-lethal launcher.

Smoke Bomb and Chemical Agent: A mix of a chemical agent with high density smoke, which also obscures the vision of the crowd. This can

either be a hand thrown canister or a round fired from a less-lethal launcher.

Muzzle Blast Round:

Shoots a blast of chemical agent from a less-lethal launcher or shotgun and is intended for close-range use. One manufacturer, Florida based Amtec Less Lethal Systems, claims its effective range is "0-30 feet based on weather conditions." According to another manufacturer, NonLethal Technologies of Pennsylvania, the round is "designed for close range crowd dispersal. When fired a cloud of irritant power agent [OC, CN, or CS] is discharged out to around 20 feet."

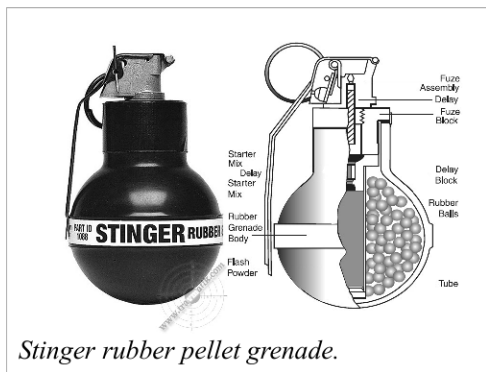

Stinger rubber pellet grenade.

Rubber Ball / Pellet Grenades:

These are grenades that are thrown into a crowd and then explode with a loud flash and bang, dispersing rubber pellets mixed with a chemical agent. The grenade may have 80-120 rubber pellets, with an effective radius of about 10-15 feet. Some brand names include Hornet's Nest Sting Grenade and the Stinger Rubber Ball Grenade. Defense Technology, the manufacturer of the Stinger (along with many other products for military and law enforcement), states that these are intended as a "pain compliance, distraction and disorientation device for crowd management."



RCMP use pepper spray canisters to disperse Mi'kmaq during Oct 17, 2014 raid in New Brunswick during anti-fracking protests.

Less-Lethal Launchers

Less-lethal launchers are specialized rifles used to fire 37mm or 40mm projectile rounds, such as rubber balls or pellets, wood or rubber baton rounds, chemical agent rounds, or a mixture of an impact round and a chemical agent.

Although widely used for crowd control, less-lethal launchers are also frequently used by police for barricaded

suspects, prison cell extractions, etc. Emergency Response Teams are among the primary users of less-lethal launchers and munitions.

Effective Range of Less-Lethal Launchers

The effective range of less-lethal launchers varies depending on the weapon and type of round fired. Manufacturers claim ranges of up to 100 metres, but according to Dave Young in the article “Special Deliveries,” published Nov 1, 2005, on Policemag.com, the actual effective range of a rubber baton round fired from a 37/40mm less-lethal launcher is around 20-30 feet, while a bean bag round may have an effective range of up to 25 feet.

According to the *Final Report of the Use of Force Committee of the Toronto Police*, published in 1998,

“Although some wildly optimistic claims are made as to the effective range.. the best ones like the ARWEN 37 and SL6 have proven effective and accurate out to about 30 yards under operational conditions” (p. 92).



Quebec police fire ARWEN 37 launcher.

ARWEN 37

One of the most common less-lethal launchers used by police in Canada is the ARWEN 37, manufactured by Police Ordnance in Markham, Ontario. The ARWEN, which stands for Anti-Riot Weapon Enfield (the designer), was first developed by the British military for use during anti-riot operations in Northern Ireland during the 1970s. They also replaced the wooden baton round with a hard rubber version at this time. Police Ordnance is now the main manufacturer of the ARWEN 37 in North America.

The ARWEN has a 5 round cylindrical magazine. It weighs 8.4 lbs. when loaded. Most ARWENs are fitted with an optical sight.



ARWEN Ace 37mm launcher.

ARWEN Ace / Single Shot

This is a single shot 37mm less-lethal launcher. The

shooter must reload by breaking the weapon open, extracting the shot round, and inserting a new one. This is how the original ARWEN was first produced.

40mm Launcher

Manufactured by Defense Technology (part of the Safariland Group, based in Florida), this is a single shot 40mm less-lethal launcher similar to the ARWEN Ace. A 37mm version is also produced.



Multiple Grenade Launcher Mk 1

Multiple Grenade Launcher (MGL)

The Sage SL6 is one of the more common MGL-type launchers used in North America, and primarily by police in the US. It is a 40mm launcher with a 6 round cylindrical magazine. The SL6 is manufactured by Sage Control Ordnance. The MGL concept was first produced in South Africa during the 1980s by Milkor, and one of their newer variations is the MGL Mk 1, used by many military and police forces around the world. The US Marine Corps also uses a version of the MGL Mk 1, known as the M32.



Pepper Ball Launcher.

Pepper Ball Launchers

These types of less-lethal launchers evolved from paint ball gun manufacturers. They look similar to paint ball guns but instead fire rubber pellets at a higher velocity. They can inflict severe bruising and swelling injuries. One producer of pepper ball launchers is Pepper Ball (based in Indiana), and one of its best sellers to police around the world is the Tac-700. This shooter has full auto capability as well as 3 round bursts. Pepper Ball claims the Tac-700 is accurate up to 60 feet. Its rubber pellets can contain chemical agents, including a high concentrate version of OC, as well as paint markers that can assist police in

arresting people after a crowd has dispersed. Pepper Ball recommends that 4-10 shots be fired at an individual, and if there is no compliance that 4-10 more rounds be fired.

RAP4 (Real Action Paintball, based in Gilroy, California), is another manufacturer of pepper ball launchers that resemble paint ball guns. They also produce versions that resemble M4 carbines, such as the T68 M4 Less Lethal Launcher, which has orange handle guards and butt stock. The T68 has an 18 round magazine as well as a 200 round 'hopper' that can be attached.

12 Gauge Shotgun

Although widely used by police and military as a lethal weapon, 12 gauge shotguns can also fire a wide variety of less-lethal rounds. These can include rubber batons, rubber balls or pellets, bean bag rounds, sock rounds, muzzle blasts, as well as mixtures of these with chemical agents.

Common shotgun models used by police include Mossberg and Remington 870. At times, shotguns are used as dedicated less-lethal weapons, and may have an orange or yellow fore stock. But any 12 gauge shotgun can be used to fire less-lethal rounds.

Less-Lethal Ammunition

Note: Rounds fired from less-lethal launchers and that contain chemical agents are listed here and described above in the section on *Chemical Agents*. All these rounds can be fired from 37/40mm launchers or shotguns.



Plastic baton round, aka "rubber bullet."

Plastic Bullet / Impact Round: Also incorrectly called rubber bullets, from which they are derived. The first rubber bullets were originally designed by the British military to replace wooden baton rounds for use in Northern Ireland, beginning in 1970. They were large, over 4 inches long and 1.5 inches wide, and comprised of dense rubber. This early version was meant to be fired into the ground and skipped into a crowd, which caused them to tumble and be highly inaccurate. Despite this training doctrine, they were frequently used to fire directly at individuals at close range. This resulted in serious injuries as well as three fatalities by 1975. That year, rubber bullets were replaced by plastic baton rounds (the L5, made of PVC) which were meant to be fired below waist level. According to Wikipedia:

“In Northern Ireland over 35 years (1970–2005) about 125,000 rubber and plastic bullets were fired—an average of ten per day—causing 17 deaths.” Half of these deaths were of children. One of the first deaths resulting from a plastic bullet was a ten year old boy, in 1975. In addition, hundreds of people were seriously injured, including blinding, brain damage, comas, damage to internal organs, and fractures.

Plastic baton rounds fired today from the ARWEN 37 are usually light green in colour and made from a composite plastic. Black versions are available that have a lower velocity. The rounds are hard and heavy, approximately 4 inches long (110mm), designed to be fired directly at an individual. The manufacturer, Police Ordnance, claims a range of 100 metres. Like their predecessors in N. Ireland, plastic bullets have continued to cause serious injuries as well as death. A version of this round includes a chemical agent payload that disperses on impact.

Rubber Bullet / Impact

Round: These are usually 3-4 hard rubber baton discs contained within a single round. They are meant to be skip fired (that is, shot into the ground and skipped into a crowd). A variant of this is made from foam rubber and is meant to be fired directly at an individual. These versions are produced by NonLethal Technology.

Rubber baton rounds for shotguns are also available, including one model dubbed a Finned Rubber (due to the presence of small stabilizing fins on the round) which is designed for direct fire at short to medium range.

The Israeli military often fires two types of rubber bullets. One is a cylindrical shaped round that contains a steel slug inside. The second is smaller with a thin layer of rubber around a steel ball.



ARWEN 40mm rubber foam baton rounds.

Bean Bag / Sock Impact

Round: One of the most common less-lethal rounds fired from a shotgun are bean bags, which are small square or round pouches filled with metal or ceramic pellets. Bean bag rounds can also be fired from 37/40mm launchers. Although seemingly harmless, the bean bag round delivers a strong impact that has resulted in serious injuries as well as death. A variation of the bean bag is the sock round.



37mm bean bag/sock round.

Foam Baton / Impact Round: These are designed to be fired directly at an individual at short to medium range. One large foam baton or 3-4 smaller discs may be contained in a round.

Rubber Balls / Pellets: Another commonly used round, disperses a number of rubber balls at a high velocity that can inflict serious injury at closer ranges. If fired from a 37/40mm launcher, these rounds can contain between 24 to 180 rubber balls, depending on their size. Shotgun versions may contain 3 large rubber balls, or between 15 to 25 smaller rubber pellets. The effective range claimed by one manufacturer for a 37mm round was between 5 to 17 metres (15 to 55 feet).

A variant is the Pepper Ball, usually fired from launchers resembling a paint ball gun, which contain a chemical agent (usually OC) that disperses on impact (see section on chemical agents, above).

Flash Bang / Stun Grenades: Also known as “Distraction Devices,” these are most often hand thrown canisters that explode with a concussion blast and blinding light. These devices can cause momentary blindness and loss of hearing. An example of a hand thrown Flash Bang is the M84. These types of explosive devices were first developed by the British military.

Projectile stun grenades can be fired from less-lethal launchers and shotguns. NonLethal Technologies claims its 40mm Distraction Round detonates at a range of approximately 115 metres. Flash Bang grenades can cause injury at close range as well as fire when used indoors.

Lethal Weapons / Firearms

All police are armed with a sidearm (a pistol) carried on their patrol belt. Currently, most police forces are equipped with 9mm pistols, which have an effective range up to 50 metres. Most police will have three magazines of 9mm rounds (one in the pistol, two in a magazine pouch on their pistol belt).

Smith & Wesson 5906: This is a semi-automatic 9mm pistol that is the standard issue sidearm for the RCMP. It has either a 10 or 15 round magazine.

Sig Sauer P226: Used by Vancouver police and several other agencies in Canada, with the P229 used by the OPP. The Canadian military also uses three variants of the Sig Sauer P model. The P226 can have magazines with 10, 15, 17, 18, or even 20 rounds.

Heckler & Koch MP5: A 9mm submachine gun of German design and one of the most commonly used submachine guns used by police and military forces around the world. In Canada and the US it is used by most police armed tactical units. It usually has a 30 round magazine, with 3 or more magazines carried in pouches. The MP5 has an effective range of up to 200 metres (depending on variant).

C8 carbine: This is the Canadian military version of the US M4 carbine (basically a shortened M16A2). The rifle fires a 5.56mm round and is commonly used by police tactical units, often with an ELCAN optical gun sight (a small scope) attached.

Has a 30 round magazine. Variants can fire full auto and semi-automatic, or a three-round burst and semi-automatic.

Some RCMP patrol officers also carry C8 carbines in their vehicles, which replaces the shotgun formerly carried as a standard long rifle. The C8 has a effective range up to 400 metres.

C7: The Canadian version of the US M16A2 assault rifle. Used by police tactical units, often in rural areas. Fires a 5.56mm round with a maximum effective range up to 600 metres. Has a 30 round magazine.



Injuries from rubber pellets.

Shotgun: The Remington 870 is a standard 12 gauge shotgun used by police forces. It can have either a 4+1 to 7+1 round internal tube magazine located under the barrel. It is commonly carried in patrol vehicles (although police are increasingly turning to the patrol carbine to fulfil this role). Armed tactical units and crowd control unit also use shotguns, which can fire a wide variety of rounds including less-lethal rounds such as bean

bags, etc.

When used as a lethal firearm, shotguns typically fire 00 Buckshot. The buckshot has about one inch of spread for every yard of distance, so it is only used for close encounters. After about 20 metres, slug rounds are usually used which can be effective up to 100 metres.

Sniper rifles: Most police snipers use a 7.62mm rifle (.308), such as a Remington 700 or 300 Winchester Magnum. These are customized hunting rifles, with scopes and a small bipod. Such rifles have effective ranges of between 800-1000 metres.

Other Police Weapons

Baton

A baton is a stick, usually around arms length, that is used for defensive and offensive purposes. There are many types of batons used by police, but the most commonly encountered are the tactical baton, the tonfa, and the riot baton.

Most police deployed as riot cops, including the Vancouver Police “Public Safety Unit”, have a 3 feet (36 inches) long hardwood baton.



RCMP Tactical Troop with riot batons.

Taser / Stun Gun

A Taser is considered a conducted energy weapon. They are frequently used by police to incapacitate individuals seen as combative, or as a pain compliance device (viewed by some as a form of torture). Tasers resemble a pistol, usually with distinctive yellow and black stripes on its side (although an all black version is available). They are usually carried on thigh holsters but are not routine issue to patrol officers (although the Canadian Police Association has lobbied for every cop to carry one). They are also not commonly used during crowd control situations, although they were used in the initial police raid at Six Nations on April 20, 2006.

The most commonly used model at this time is the X26, produced by Taser International, based in Scottsdale, Arizona. The X26 has various cartridge ranges, but the maximum range is 35 feet. A newer version, the X26P, has a video camera and flashlight built into it. There is also the X2, which has a second shot capability. The X2 can be distinguished from the X26 variants by having two separate firing panels (as opposed to one). Many police forces in the US now reportedly use the X2, and it can be expected that police in Canada will also adapt it in the near future. Each X26 can cost up to \$1,000, while the X2 can cost up to \$1,300 each.

How a Taser works: Tasers are aimed and fired like a pistol, most often with a red dot laser beam to assist in aiming. When fired, two small darts attached to fine wire cables are shot out, which remain attached to the Taser. In order to function, both darts must be attached to the person. These darts are designed to penetrate clothing and embed themselves in a person's skin. They are barbed to make removal difficult. A Taser's dart does not have to make direct contact with skin as it can jump up to 2 inches through clothing material (including thick leather and even Kevlar vests). They can discharge up to 50,000 volts of electricity, overwhelming the central nervous system and usually causing immediate incapacitation as muscles involuntarily tense up. Many people fall, while some go unconscious, after being tasered.

The initial electrical charge usually lasts approximately 5 seconds, but this can be adjusted by the user. Additional pulses can be sent by the shooter pressing the trigger. One person killed from a Taser was shocked 9 times. Some reports state that a Taser can be continuously applied for up to a minute, when its battery dies.

Once a Taser is fired, a new cartridge must be loaded (with the exception of the Taser X2 and X3, which have 2 or 3 cartridges, respectively). A Taser can also be held to a person

and activated, without firing the darts (referred to as Drive Stun). In this mode it is used as a "pain compliance" weapon. The shock cycle can be stopped by placing the safety on. Persons that touch the tasered individual will not be shocked. Like other electrical devices, Tasers can cause fires when used near flammable materials, such as gasoline, gas vapours, meth labs, or even pepper sprays that contain alcohol.

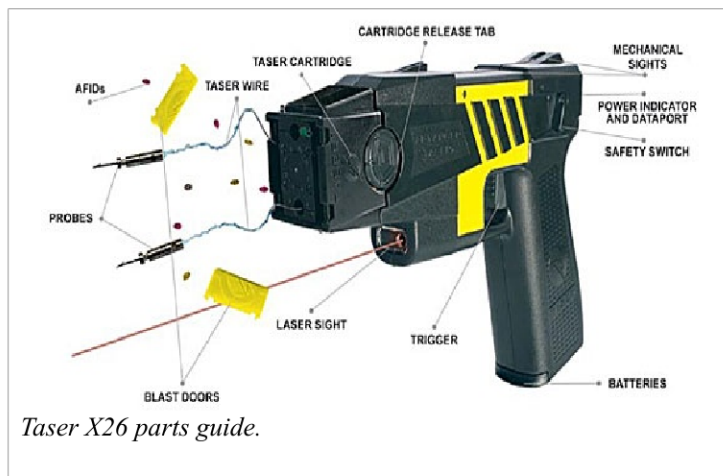

Taser X26 parts guide.



Taser dart stuck in the eye.

Injuries and Fatalities:

Some people who are briefly tasered recover almost immediately, while others may experience difficulty

walking and breathing properly and take several minutes to fully recover. Injuries from a Taser dart and accompanying shock

include cardiac arrest, blinding (when the dart penetrates the eye), burn wounds, punctures and infection (from the darts), as well as hernias and fractures. Falling is a common response to being tasered, often resulting in head injuries, bruising, as well as fractures. Some people lose consciousness. Tasers have also resulted in hundreds of deaths over the years.

Defence Against Taser

Shields or packs used as shields can block taser darts.

Carbon fibre textile reportedly defeats the electrical charge of Tasers and stun guns. This material can be purchased in a variety of forms, including upholstery fabric. Carbon fibre tape is also reportedly used to line the inside of clothing as defence against Taser strikes. Another defence is evasion.

First Aid for Taser:

- Calm, comfort, and reassure the casualty.
- Treat injuries resulting from falls.
- Treat darts as impaled objects if embedded in the skin, treat the wound.
- Treat any burns left by the darts.
- In the event of localized muscle spasms, ice the affected area.
- Monitor/treat for shock, advise rest.
- Restore the electrolyte level of the person's body. This can be done with Emergen-C, or water with a banana.

LRAD / Long Range Acoustic Device

The LRAD is both a very powerful public address system as well as an acoustic weapon. The LRAD was first used in N. America as an acoustic weapon during the G20 summit in Pittsburgh, 2009, when police deployed one against protesters. Since that time, more police forces throughout N. America have acquired them. The Vancouver police acquired an LRAD just prior to the 2010 Olympics, claiming it was solely for use as a PA system to address crowds. Both the Toronto and Chicago police also bought LRADs just prior to major economic summits.



Small hand held LRAD, Toronto police.

As an acoustic weapon, the LRAD emits a powerful sound wave that affects not just hearing but the entire body. In Pittsburgh, it sounded like a high pitched siren. To be effective, the person(s) must be in front of the LRAD where the beam is directed. One of the most common types of LRADs used by police is the 500X model, usually a square black device 25" X 25". It can be vehicle mounted or carried and erected on a collapsible tripod. Two options that can be fitted to the 500X are a powerful white light and a green laser dazzler. Some reports states that the 500X, when used as an acoustic weapon, can be effective up to 300 metres.



A larger LRAD.

Defence against LRAD: Against the LRAD as an acoustic weapon, wearing ear protection (such as ear plugs or ear protectors) can reduce the effects. Placing a solid object, such as a shield or sheet of plywood, for example, between oneself and the LRAD, reportedly blocks the sound wave.

Armoured Vehicles

With the ongoing militarization of police around the world, many departments now have armoured vehicles as part of their heavily armed tactical units. These are predominantly 4 wheeled armoured cars, used to transport personnel and protect them from small arms fire. Some are fitted with battering rams used to punch holes in structures. They may be used during large crowd control situations as a protective vehicle for cops and for barricade removal.

The first use of armoured vehicles against Indigenous land defenders in Canada occurred in 1990, during the Oka

Crisis, when the 5th Mechanized Infantry Brigade of the Canadian Forces was deployed. The military used Grizzly and Cougar armoured vehicles in both Kanehsatake and Kahnawake for operations to dismantle warrior barricades and during a raid on the Kahnawake Longhouse.

Following Oka, a strategy of criminalization against Indigenous resistance was employed, including better equipping of police to contain future confrontations. This strategy was seen in the summer of 1995 in two separate conflicts.

During the month-long siege at Ts'Peten (Gustafsen Lake) in south-central BC, RCMP ERT units were provided with 8-9 Bison armoured personnel carriers from the Canadian Forces (including a crew of two for each APC). The RCMP used these



RCMP TAV armoured vehicle in background during Oct 17, 2013, raid on Mi'kmaq blockade in New Brunswick.

vehicles to conduct patrols around the Sundance camp and, on Sept 11, to carry out an assault on the defenders. During an ensuing firefight, one of the Bisons was disabled by gunfire and its personnel had to be rescued by another Bison.

During the re-occupation of Ipperwash Provincial Park by members of the Stoney Point band in southern Ontario, the OPP had two Bison APCs on standby (although they were not deployed).

Today, most police in large cities have an armoured vehicle. The OPP and SQ both have armoured vehicles, as does the RCMP, the national police force of Canada. These vehicles are used by armed tactical units, such as the RCMP's Emergency Response Team (ERT) or the OPP's Tactical Response Unit (TRU). These tactical units are usually deployed during crowd control operations, and are frequently used during Native blockades for both surveillance and lethal over watch. It should also be noted that police agencies may have arrangements with nearby military bases for the use of armoured vehicles (in March 2005, RCMP ERT responding to the shooting of four cops in Mayerthorpe, Alberta, requested three armoured vehicles from CFB Edmonton, which were dispatched to assist in a possible standoff).

It is likely that Native communities engaged in resistance activities in the future, such as blockades or land reclamations, will be faced with police using armoured vehicles. For this reason, it is good to know some of the types of armoured vehicles police forces have at their disposal, and the geographic regions in which they are located.

Armoured vehicle specifications:

Most, if not all, of the armoured vehicles used by police have the following attributes:

Armoured plating and windows that are resistant to small arms fire (i.e., 5.56mm or 7.62mm). Newer models, such as the MRAPs, have reinforced and specially shaped hulls to resist explosive devices and mines.

Firing ports on the side and rear, which enable persons inside the vehicle to fire their individual weapons outward. These ports have ballistic covers that can be opened and closed by those inside. In crowd control operations, police inside the vehicle could fire less-lethal weapons including projectiles as well as pepper spray through these gun ports.

Run flat tires and rims that enable the vehicle to maintain mobility even when the tires are punctured and deflated.

Balkan Mk 7

Used by the Calgary Police Service Tactical Unit (in Alberta). Purchased in 2008 for \$250,000, manufactured by Ontario-based Armet (now out of business).

Personnel: Crew of 2, plus 8 personnel

Weight: 8618 kg / 9.4 tons **Length:** 2.9 metres **Width:** 2.3 metres **Height:** 2.5 metres **Range:** 600 km **Speed:** 130 kmh



Balkan Mk 7 used by Calgary police

BATT (Ballistic Armoured Tactical Transport)

Used by Sault Ste. Marie Police Service's Emergency Services Unit (in southern Ontario). Purchased in 2011 for \$225,000 from Armoured Group LLC (based in Arizona). Based on the Ford F-550 4x4 Chassis

Personnel: 10-12 including driver. **Speed:** Up to 80 mph



BATT armoured vehicle used by Sault Ste. Marie police.

Bison

Not currently used by police, nine Bison APCs were used by RCMP ERT units during the 1995 siege of Ts'Peten (Gustafsen Lake, BC). These were supplied by the CF, along with their crews. They are still in service with the CF as a support vehicle (i.e., ambulance, communications, etc.), though no longer used as an APC for infantry. It is possible that Bison APCs could be delivered to police, as with the decommissioned Cougar and Grizzly armoured vehicles. Originally manufactured by General Motors Diesel Division (now General Dynamics Land Systems Canada) in London, Ontario.

Personnel: Crew of 2, plus 8 personnel

Weight: 12.39 tons **Length:** 6.45 metres **Width:** 2.5 metres

Height: 2.21 metres **Speed:** 100 kmh **Range:** 665 km



Bison armoured personnel carrier.

BearCat

Used by Ottawa Police Service Tactical Unit (Ontario), Saskatoon Police Service Emergency Response Team (in Saskatchewan), and the Abbotsford Police Department Emergency Response Team (in BC). Manufactured by Lenco Industries Inc., based in Massachusetts.



BearCat armoured vehicle in use by Ottawa police.

Personnel: Crew of 2 + 10 personnel

Weight: 8.7 tons **Length:** 6 metres **Width:** 3 metres

Height: 2.4 metres **Speed:** 120 kmh

Cougar

Used by RCMP Emergency Response Team in Greater Vancouver Region (BC), donated in 2010 from CF, and the New Glasgow Regional Police Service Emergency Response Team (Nova Scotia), donated by CF in 2013. At that time, the defence minister stated that Cape Breton Regional Police and the Windsor, Ontario, Police Service had also made requests for surplus Cougars. May also be provided to other police forces over time. Police version has turret and small cannon removed.



RCMP Cougar armoured vehicle, referred to as TAV 2.

Personnel: Crew of 3 in military version. Perhaps 7-8 personnel in police model (?).

Weight: 10.7 tons **Length:** 5.97 metres **Width:** 2.5 metres
Height: 2.62 metres **Speed:** 100 km/h **Range:** 600 km



Dragon Patroller, used by Surete du Quebec (SQ)

Dragon Patroller armoured security vehicle

Used by Security du Quebec (SQ) Emergency Response Team (in French, GTI: *Groupe tactique d'intervention*, or tactical intervention group). Has a battering ram pole attached for punching through walls or doors.

Personnel: Up to 12, including driver.

Weight: 12,700 kilograms (28,000 lb)

Length: 5.89 metres (19.3 ft) **Width:** 2.49 metres (8 ft 2 in)

Height: 2.819 metres (9 ft 3.0 in) turret roof

Range: 885 kilometres (550 mi)

Speed: 116 kilometres per hour (72 mph) road, 4.8 kilometres per hour (3.0 mph) water

Gurkha

Used by Peel Regional Police Tactical Rescue Unit, Airport Division. Equipped with MARS (multi-access ramp system). Built by Ontario-based Terradyne Armored Vehicles Inc., based on the Ford F550 chassis.

Personnel: 8-10

Weight: 8,600 kg (19,000 lb) **Length:** 5.5 m (18 ft 1 in)

Width: 2.16 m (7 ft 1 in) **Height:** 2.5 m (8 ft 2 in)

Range: N/A **Speed:** 150 km/h (93 mph)



Gurkha armoured vehicle used by Peel Regional police.

Grizzly

Acquired by Edmonton Police Service Tactical Unit in 2007, donated by CF. Used by New Glasgow Regional Police Emergency Response Team, donated in 2013 by CF.

Personnel: 9, including driver.

Weight: 10.5 tons **Length:** 5.96 metres **Width:** 2.53 metres

Height: 2.53 metres **Range:** 600 km **Speed:** 101 km/h



Grizzly APC with battering ram used by Edmonton police.

Hummer H1 Armoured

Used by Surete du Quebec Emergency Response Team, a civilian version of the US military Hummer truck, with armour added on.

Personnel: 5 including driver.

Weight: 2.34 tons **Length:** 4.7 m

Width: 2.12 m **Height:** 1.75 metres

Range: over 500 km **Speed:** 105 - 112 km/h



Nyala RG-12 used by London police, with MARS ladder system used for entering planes or buildings.

Nyala RG-12

Used by London Police Service Emergency Response Section, donated in 2005 by General Dynamics. Based at airport and equipped with MARS.

Personnel: Up to 12, including driver.

Weight: 11500 kg **Length:** 5.8 metres **Width:** 2.3 metres

Height: 3.7 metres **Range:** N/A **Speed:** 100 kmh



RCMP Tactical Armoured Vehicle (TAV).

Personnel: 10, including driver.

Weight: 7.1 tons **Length:** 6.2 metres **Width:** 2.4 metres

Height: 2.5 metres **Range:** 640 km **Speed:** 100 km/h



Nyala RG-31 used by London police.

Nyala RG-31

Used by London Police Service Emergency Response Section, donated in 2011 by General Dynamics. Also used by Durham Regional Police Service, donated by General Dynamics in 2013. An MRAP widely used in Iraq and Afghanistan.

Personnel: Up to 11, including driver.

Weight: 7.3 tons **Length:** 6.4m **Width:** 2.47m **Height:** N/A

Range: 900km **Speed:** 100km/h

Tactical Armoured Vehicle

18 TAVs were acquired in 2012 by the RCMP for use by Emergency Response Teams throughout RCMP divisions. Cost: \$14 million for the fleet, manufactured by Navistar Defence Canada (the TAV is a variation of their MXT APC, used by British and Canadian military). RCMP detachments are present in all provinces and territories except Ontario and Quebec. They may also be called in to assist municipal and provincial police forces as necessary. The TAV has an armoured turret on top.



Thunder 1 APC used by various police forces.

Thunder 1

Used by Vancouver Police Department ERT, purchased in 2010 for \$350,000. Acquired that same year by Ottawa Police Service, York Regional Police (2011), Ontario Provincial Police (2 delivered in 2012), Quebec City Police Service (2012), and Montreal Police Service (2013). Manufactured by Cambli International, based in Quebec.

Personnel: 10-14, including driver.

Weight: 12,700 kg / 14 tons **Length:** N/A **Width:** N/A

Height: N/A **Range:** N/A **Speed:** 128 km/h (80 mph)

Trooper

Used by Toronto Police Service's Emergency Task Force, acquired in 2005 for \$250,000 and built by Ontario-based Armet (no longer in business). Based on Ford 550



Trooper used by Toronto police.

4x4 chassis. **Personnel:** Up to 14, including driver.

Defence against armoured vehicles

Military anti-armour manuals have various means of defeating armoured vehicles, but most of these involve weapons that land defenders are unlikely to possess (such as anti-tank rocket launchers, mines, etc.).

One tactic that is recommended is the digging of anti-tank ditches across a roadway (or open field). To be effective, the ditch must be at least 3 metres in length and 1.5 metres deep, as wide as the roadway (or field, etc). Ditches can be dug either by shovel or with a front end loader. The dug up earth can be piled up to increase the height of the ditch on the side opposite of

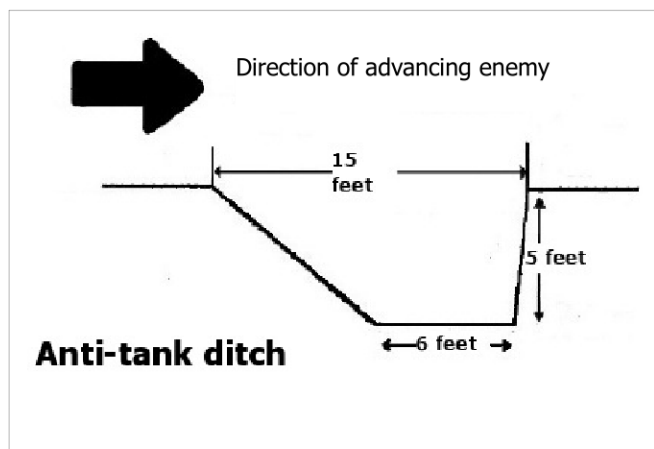

the enemy's approach. Anti-tank ditches can also be concealed with sheets of plywood covered with a thin layer of earth (for example).

Armoured vehicles are also vulnerable to tipping over on uneven terrain; in Afghanistan, a Canadian LAV 3 armoured vehicle was hit by a car and toppled over an embankment.

In riotous situations, it appears that the most common tactics used against armoured vehicles consist of Molotovs, building barricades to prevent their movement, and paint bombs to obscure their vision. Barricades need to be heavy enough that they cannot be simply pushed aside by the armoured vehicle.



Syrian tanks caught in an anti-tank ditch; in the background is a pontoon bridge used to move tanks over the ditch, with one tank having fallen off.

Water Cannons

Water cannons are very large trucks with one or more cannons that can shoot water at a high velocity up to a range of 50 metres or more. They are used to disperse crowds, target individuals in a crowd, and to extinguish fires (such as burning barricades, trash bins, etc.).

Water cannon trucks can carry between 8,000 to 12,000 litres of water and can shoot in a continuous stream or pulses, as a hard jet or as a spray. They can also have dyes or tear gas added (the dye is used to identify crowd members for later arrest). The force of the water can be strong enough to knock people over, resulting in serious injuries and even death.

Water cannons are frequently used in W. Europe (including Northern Ireland, Germany, as well as Turkey) and in Chile. They are not often deployed by police in Canada or the US.

For the 2001 Summit of the Americas in Quebec City, police had two water cannons that were used to force crowds back from sections of security fencing. One had its unprotected side window smashed with a rock and the vehicle was withdrawn. It is not known if these vehicles were rented or what became of them after the Summit.

For the Toronto G20 in June 2010, the RCMP acquired a new water cannon that closely resembled the ones used in 2001. This version had metal screens over the front and side



Water cannon used in Quebec City, 2001.

windows. It was not deployed during the protests and it is unknown where this vehicle is normally stationed or if the RCMP still have possession of it.

Both these models of water cannons (called "water projection systems" by the RCMP) resembled fire-fighting trucks used at airports, equipped with what are called "deck guns" (the actual water cannon).

Defence against water cannons: Water cannon trucks are slow and hard to manoeuvre. Some defences used against water cannons have included shields (such as sheets of plywood), barricades, and attacks on the vehicles themselves (including Molotovs and paint bombs). Anti-tank ditches would also be effective against a water cannon travelling on a road.

Blockades

“[T]he frequency and intensity of Native blockades in BC suggests that it is seen as a particularly effective form of direct action. Indeed, the blockade need not be established to be effective; its threatened use may be enough.”

Nicholas Blomley, “Shut the province down,” p. 17, *BC Studies*, No. 111, Autumn 1996.

Blockades are a common tactic used by Indigenous peoples, whether in Canada, Mexico, or Brazil. They are used primarily to stop vehicle traffic, including commercial traffic, specific equipment used in a resource exploitation project, as well as trains. They may be used to disrupt economic activity or to deny access to an area. Some blockades have been established to defend a community against invasion by settler vigilantes and/or police (i.e., the blockades set up around Kahnawake in 1990).

Types of Blockades

Nicholas Blomley, in his article “Shut the province down” (*BC Studies*, No. 111, Autumn 1996) identifies three types of blockades which he terms the information checkpoint, the partial blockade, and the full blockade. Some people refer to “soft blockades” and “hard blockades.”

Information Checkpoint

Not a true blockade, the checkpoint temporarily stops traffic to distribute information, such as leaflets. It is a tactic used to slow traffic (causing a minimal level of disruption), raise public awareness about a campaign, and at the same time serve as a warning to authorities. Informational pickets are often used by grassroots groups as well as *Indian Act* band councils (as forms of “civil disobedience”).

From July 27 to August 4, 2000, the St'at'imc conducted an information checkpoint on Hwy. 99 at the site of the Sutikalh camp (near Mt. Currie, BC). They distributed 1,500 leaflets and collected hundreds of signatures on a petition against a proposed ski resort in an alpine area. The threat of a full blockade, along with substantial grassroots organized, pressured the band councils into also opposing the ski resort, which was eventually defeated.

Partial Blockade

This blockade targets certain types of vehicles, most commonly logging trucks and/or commercial trucks, while allowing other types of local traffic through. A partial blockade must have an obstacle that can be quickly moved on/off the roadway.

In late June and early July, 2001, participants and supporters of the Sutikalh camp established a partial blockade on Hwy. 99 that turned back all commercial vehicles, including logging trucks, oil tankers, cargo trucks, etc. Non-commercial traffic was allowed to pass. A spike board was used to block the roadway. Over 60 RCMP raided the camp, using a helicopter, dog teams, ERT, and an armoured vehicle. Seven unarmed persons were arrested.

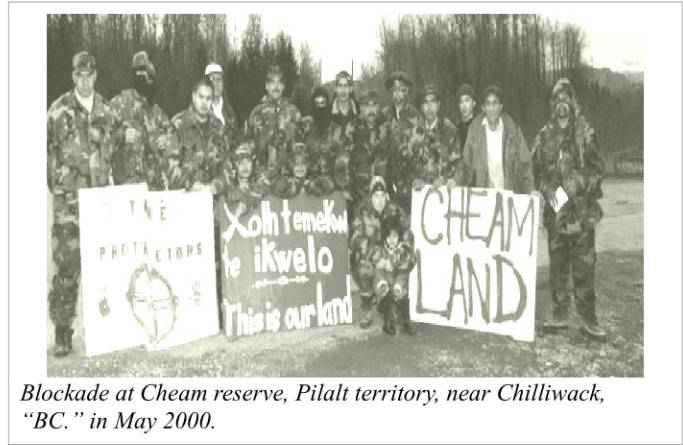

Blockade at Cheam reserve, Pilalt territory, near Chilliwack, “BC.” in May 2000.

Full Blockade

All traffic is stopped. Full blockades of roadways have been achieved using simple spike boards, vehicles, or trees. In 1990, the St'at'imc at Mount Currie, BC, established a blockade on the Duffey Lake Road. It was comprised of a series of 3 foot high earth mound across the roadway, along with couches and tents that blockaders stayed in. The blockade lasted four months until a large force of RCMP moved in to dismantle it on November 6, 1990.



Tyendinga Mohawks block train & road with bus, 2007.

Blockade Tactics and Techniques

Military manuals suggest that road blocks be placed:

- at choke points, to block the smallest pass (not the widest). For example, on a bridge or in a narrow canyon pass, or on a roadway with heavy forest on either side, etc.
- so that they look down on opposing forces, not up (for example, near the top of a hill).

Vehicles

Many Native blockades are established by simply parking vehicles across the roadway. This has the advantages of being a large barrier that is easily put in place, and which can also be quickly moved on or off the road. Disadvantages include the owner of the vehicle possibly facing charges, the vehicle itself being damaged by vigilante citizens or police, or the

vehicle being seized if police overrun the blockade.

Some blockades have used abandoned or wrecked vehicles to block a roadway.

When Quebec police raided the Mohawk blockade at Oka/Kanesatake on July 11, 1990, warriors used several abandoned police cars to establish a hasty blockade on a nearby roadway. These vehicles were put in place by a front end loader, and the vehicles themselves were destroyed. The barricade was reinforced over time and persisted throughout much of the summer long standoff.

Shortly after the raid on Kanesatake, Mohawk warriors at Kahnawake seized the Mercier Bridge, a vital commuter link into Montreal. They drove their vehicles onto the bridge and blocked the roadway. When cars began driving around them, they pulled out assault rifles and established an armed blockade, forcing cars back and down off the bridge. This hasty blockade was also reinforced over the days and weeks that followed, including the construction of sand bagged positions (protection against small arms fire).

In 1993, members of the Cheam band in BC blocked a railway by parking heavy machinery on the tracks, threatening to tear the tracks up if the RCMP raided the blockade.

In September 1995, following the police shooting of Dudley George at Ipperwash, Natives set up a road block using an abandoned vehicle that was set on fire. In 2000, Mi'kmaq at Burnt Church, New Brunswick, also blockaded a road using an abandoned car set on fire to prevent RCMP and/or vigilante citizens from entering the reserve-territory.

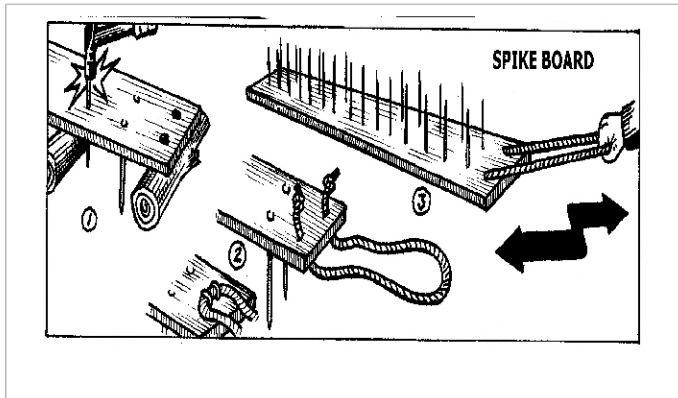

Spike boards

Another technique often used to establish a blockade is the use of a spike board (at least in south central BC). Similar to the spike belts used by cops, a spike board consists of a piece of lumber with large spike nails hammer through one side. This is laid across the roadway, and is pulled off/on with a rope handle attached to one end. If a vehicle refuses to stop, they will drive

over the spikes and puncture their tires.

Spike boards were used during blockades in the south central BC region during the spring of 1995, and during a 10 day blockade of commercial vehicles on Highway 99 at the Sutikalh camp (St'at'imc territory) in 2001.



Abitis of cut down trees.

Trees / Abitis

Some hasty blockades have been established by cutting down trees so that they fall across the roadway, making them impassable. A military term for this technique is *abatis* (or *abattis*), with the trees felled so that they cross over top of one another. Historically, abatis were made of branches pushed into the ground with their sharpened tips pointed toward the enemy. An abatis made of trees can be dismantled fairly quickly by forestry workers equipped with chainsaws, or by heavy trucks equipped with cables that pull the trees off the roadway.

Felled trees were used during the 1995 siege at Ts'Peten (Gustafsen Lake) in south central BC (Secwepemc territory), and during the October 2013 Mi'kmaq blockade of fracking vehicles in New Brunswick.

The Piqueteros "hasty blockade" and tire fires

The *piqueteros* of Argentina, a movement of poor and unemployed people that arose in the late 1990s, developed the hasty blockade to a high level. During large mobilizations, and through coordination between many autonomous groups, they used hasty blockades to paralyse the transportation infrastructure of the entire country. In August 2001, for example, the piqueteros were able to shutdown some 300 highways and roads throughout the country.



Piqueteros with sticks and tires ready to set ablaze.

The most common tactic used by piqueteros was to arrive on a road, highway or city intersection, and block it with tires. Small fires were often built in the middle of the road, and if necessary the tires themselves were set on fire, often by inserting a few plastic bags doused with gasoline into each tire's rim and igniting them. The burning plastic bag would quickly

ignite the rubber on the tire (tire fires, it should be noted, are highly toxic and could be hazardous to residents in a densely populated area).

In one case, a hasty blockade established by piqueteros consisted of the unravelling of a chain link fence and extending it across a roadway, where it was secured to a telephone pole.

The piqueteros, a movement based in community and family groups, would also have a self-defence force at their blockades, usually masked people armed with batons. The batons became one of the symbols of the movement. These groups would defend the blockade against any vigilante actions by motorists as well as assaults by small numbers of police. Piquetero blockades often lasted until police had mobilized a large enough force that threatened the blockade, at which point they dispersed.

State Repression of Blockades

Unless there is an imminent emergency, or the pretext of one manufactured by police, blockades usually initiate a legal process by the group being blockaded (such as a logging or mining company, or a government agency). The legal process begins with the target group applying to the courts for an injunction ordering the removal of the blockade. This same legal process applies to occupations as well.

When a group applies for an injunction, it is common for the blockading group to file a counter-injunction to show why an injunction should not be issued. At times, the courts may refuse to issue an injunction if it can be shown that there is no imminent need for a roadway to be re-opened, and negotiations may be recommended to end the dispute.

In the prelude to the 1990 Oka Crisis, there were months of injunctions and counter-injunctions applied for by the municipal government (who wanted to expand a golf course and condominium development) and Mohawks (who opposed the expansion and construction). Eventually the courts issued an injunction, which the SQ attempted to enforce on July 11.

When courts do issue an injunction, it is then a policing matter, and the police have some control over when and how the injunction will be enforced. It is common for police to delay enforcement action for several days as they mobilize a large enough force to dismantle the blockade if necessary. During this time, police will frequently use deception to convince the blockading group that no action is imminent.

Most police raids on blockades have occurred in the early morning hours. At Kanasatake on July 11, 1990, the SQ

raided the Pines at around 5:15 AM. The 2001 RCMP raid on a ten-day long blockade at Sutikalh occurred at 5:00 AM. During the Six Nations land reclamation in 2006, the OPP raided the blockade site at around 4:30 AM. on April 20, despite explicitly stating the day prior that they had no intentions of taking enforcement action.



Some blockades, primarily those established by band councils, are handled as acts of 'civil disobedience' and are coordinated with the police. When the enforcement of an injunction occurs in these cases, there is usually a warning provided so that those not wishing to be

arrested can move aside. Those who remain are then arrested and charged, usually with obstruction for disobeying the injunction.

In 1985, the Haida, largely under the direction of the band councils, erected a blockade against logging on Lyle Island. The courts issued an injunction against the blockade, and the enforcement action was carefully scripted with the police. Eventually 71 people were arrested. Most later had their charges dropped, and just 9 Haidas were convicted. They were each given 5 month conditional sentences (meaning no jail time).

Compare this to the 2001 grassroots blockade at Sutikalh, for example, during which 7 persons were arrested by a large paramilitary RCMP operation.

They were charged under Section 423 (1) (g) of the *Criminal Code of Canada* of using intimidation by blocking a highway. In November 2002, four of those arrested received jail terms up to 4 months, two young women were given conditional sentences, while a seventh had already served his jail time during pre-trial custody.

In the case of Sutikalh, there was no legal process involving injunctions and police instead proceeded on criminal charges. This also occurred during the anti-Sun Peaks ski resort campaign carried out by Secwepemc peoples near Kamloops, BC, in 2001. Several hours after a blockade was established on the main road into the ski resort, RCMP arrested the participants for intimidation. Those arrested later received jail terms of up to three months.

Likewise, during an October 2003 blockade in Cheam of a CN railway cutting through the reserve-territory, it took the RCMP just 4 hours to mobilize 30 officers and dismantle the blockade, arresting 7 people (almost all women, including one who had her arm broken by cops).



Oka 1990: abandoned cop cars can also be used for barricade materials, FYI.

Notes from "Shut the province down"

Vulnerability of transportation infrastructure

"Most of British Columbia's scanty population live in a few urban centres, most notably, of course, in the extreme southwest of the province. This population is dependent on an attenuated transport system made up of a few major road and rail routes. The low-density population and the rugged terrain mean surprisingly few transport connections. At the same time, the provincial economy is still largely dependent on gaining access to increasingly isolated pockets of resources, such as timber. Vast amounts of usually unprocessed raw materials are then hauled out for delivery to distant export markets. The result is that the closure of one or two transport routes can have profound consequences. While many blockades have been on relatively minor routes, such as logging roads, a well-placed blockade on a major transport route can have profound consequences. Of special significance were the closures of the Duffey Lake Road in the summer of 1990 (which cut off the towns of Pemberton from the east and Lillooet from the west) and the Stolo [actually Pilalt of the Cheam band] blockade on the main CN Rail line into Vancouver in 1993 (which cost CN around \$3 million a day).

"The vulnerability of the transport system is further aggravated by the fact that road and rail lines frequently pass through reserves, which are, as noted, the usual location for blockades. Not only are such transport corridors an obvious focus for First Nations, given their proximity and their strategic importance to the provincial infrastructure, but they are themselves a frequent source of irritation, given the presumptuous manner in which they were established. For example, temporary access routes, such as logging roads, can become so used by non-Natives that, over time, the assumption becomes that they are public rights of way, although access may, in law, be entirely at the discretion of a band council. Denied access by a blockade, aggrieved non-Natives may condemn Native actions as a violation of their right to travel when, in fact, they may themselves be in trespass. This was at issue, for example, in the dispute at Adams Lake in early 1995.

(Nicholas Blomley, "Shut the province down," p. 18, *BC Studies*, No. 111, Autumn 1996)

"In the case of blockade activity, a system of colonization has itself become the focus and the weapon in a counter-colonial struggle. Transport lines are vulnerable due to the export orientation and resource base of the provincial

economy, the dispersed nature of the transport system, and the location of transport corridors relative to reserves.

(Nicholas Blomley, "Shut the province down," pp. 20-21, *BC Studies*, No. 111, Autumn 1996)

Train blockades

"Rail lines are often the target of Native blockades. Again they are an easy target because they frequently bisect reserves. BC Rail lines, for example, run through or beside twenty reserves in British Columbia. The existence of such routes, and the process by which they were established, often remains a point of disagreement for generations, thus resulting in rail lines often being seen as logical sites of protest."

(Nicholas Blomley, "Shut the province down," pp. 19-20, *BC Studies*, No. 111, Autumn 1996)

Mobility of Native blockades

"Finally, blockades are not necessarily tied to an individual location but, on occasion, can be reallocated, more or less at will, along a given transport corridor. This is especially the case given that, in most cases, a blockade is little more than a symbolic line marked, perhaps, by a flag

or spiked board. This flexibility can be of great consequence, and it distinguishes First Nations blockades from those that are necessarily tied to a specific site, such as the union picket.

"A striking, if somewhat unusual, example of this occurred between 24 July and 26 August 1990, when the Seton Lake, Fountain, Pavilion, and Mount Currie Bands blockaded the BC Rail main line to show solidarity with the Mohawk at Oka and to air their grievances over unresolved land claims. The first rail blockade at Seton Portage was dismantled when it was reported that an RCMP riot squad was en route to the site, but it was then re-established at a Mount Currie location. The track was again blocked at Seton Portage, and an RCMP raid led to several arrests. This prompted the re-establishment of the blockade at Mount Currie, which, in turn, was dismantled when it was learned the police were en route. The Seton blockade was set up a third time; this time the only road access route to Seton Portage was also blockaded in order to prevent the RCMP from serving an injunction."

(Nicholas Blomley, "Shut the province down," pp. 21-24, *BC Studies*, No. 111, Autumn 1996)



Mi'kmaq warriors set a tire fire blockade alight on a highway, Dec 4, 2013, during anti-fracking resistance.

Notes from US Army Counter-Mobility Operations manual



Barricade in Bangkok, Thailand, with tires, sharpened bamboo poles, and razor wire.

The US Army's Field Manual on *Countermobility Operations* (FM 5-102) suggests various methods for denying enemy forces vehicular movement. These include destroying bridges, cratering roads, cutting trees (*abatis*), placing rubble or damaged vehicles on the roadway, digging anti-tank ditches, flooding, and the use of fire.

“The potential of expedient obstacles is almost unlimited. They place a great premium on imagination and ingenuity in the use of available materials and other resources, thus avoiding the logistic burden associated with all other types of obstacles. All sorts of nonstandard log obstacles can be built. Their complexity depends upon the time and personnel available. Junked or destroyed cars and trucks or other debris can be spread to block an open area or, if the region is rocky, earth moving equipment can be used to distribute boulders to block tanks. Selected trees can be pushed over to make an *abatis* or to strengthen a wooded area where tree spacing might otherwise allow armored vehicles to pass. Short ditches can be cut in lieu of craters. Material can be pushed up to form a road block. Equipment can steepen or deepen stream banks, gullies, or other breaks in the terrain to make expedient tank ditches. Trees can be cut or broken with a variety of vehicles or pieces of equipment. They can also be pushed or pulled down by winches to form expedient *abatis* or strengthen wooded areas. The M9 Armored Combat Earthmover (ACE), dozers, loaders, and many other pieces of equipment can also be used.

“The wreckage of destroyed towns, cities, or industrial areas offers a source of materials to be used in making expedient obstacles. If permitted, limited controlled flooding can be used, not only to inundate areas, but also to create soft or slippery areas where soil conditions would make this possible. Timber bridges can be burned, and controlled fires can be used to create obstacles in other ways. For example, igniting the brush in a brush-filled ditch, at the proper time, can make an effective obstacle. If available, ice and snow can be exploited to create

effective obstacles.

“By their nature, expedient obstacles substitute locally available materials and soldier labor for a logistical requirement. All that is needed is the imagination to recognize the potential of available materials.”

Build Obstacles in Depth

“A series of simple obstacles arranged one behind the other along a probable axis of enemy advance is far more effective than one large, elaborate obstacle. Restricting the design of obstacles to correspond with the strength of the existing obstacle (as previously discussed) helps to conserve effort and direct it toward executing obstacles in depth. Obstacles must not be located too close together so only a single enemy response is required. They must be far enough apart that each will require a new deployment of the enemy's counter obstacle forces and/or equipment. The distance between obstacles will depend on the terrain and the obstacle effort available. Proper use of obstacles in depth wears the enemy down and significantly increases the overall delay. At each new obstacle, he incurs losses and is forced to stop and react. This wearing down effect is psychologically significant. The desired effect is to degrade the enemy soldier's will and induce a feeling of hopelessness. This can be done by convincing him that, beyond each new obstacle (with its attendant loss of personnel and equipment), there awaits another obstacle with a similar cost; and, beyond that one, yet another, and so on. Another reason for using a greater number of less elaborate obstacles is that each one forces the enemy to expose his limited counter obstacle equipment and troops to loss. When the counter obstacle resources initially allotted to the leading elements have been destroyed, the enemy's movement will be severely slowed until new counter obstacle units can be brought forward.

(“Chapter 2: Countermobility Fundamentals,”

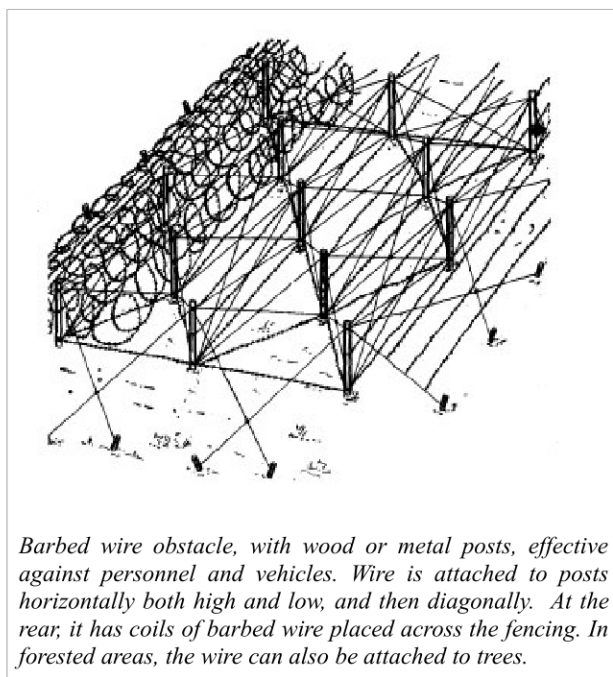

Barbed wire obstacle, with wood or metal posts, effective against personnel and vehicles. Wire is attached to posts horizontally both high and low, and then diagonally. At the rear, it has coils of barbed wire placed across the fencing. In forested areas, the wire can also be attached to trees.

Countermobility Operations, FM 5-102)

DEFEND THE TERRITORY!



WARRIOR PUBLICATIONS

WARRIORPUBLICATIONS.WORDPRESS.COM