

ELECTRONIC VERSION

The Unofficial  
**MACGYVER**  
How-to Handbook



To order a print copy go to  
[www.macgyverbookbook.com](http://www.macgyverbookbook.com)

BRET TERRILL | GREG DIERKERS

## **ELECTRONIC VERSION**

To order a print copy go to

[www.macgyverbookbook.com](http://www.macgyverbookbook.com)

# The *Unofficial* MacGyver How-to Handbook:

Actual Working Tricks as Seen on TV's  
MacGyver

Revised 2nd Edition

Bret Terrill  
and  
Greg Dierkers

Illustrated by Patience Gallegos

Cover Design by Timothy Thul

The Unofficial MacGyver How-To Handbook  
Copyright © DECEMBER 2005 by Bret Terrill.  
ISBN 1-887641-47-5

Published by American International Press. All rights reserved.

[www.aipbooks.com](http://www.aipbooks.com)

*We'd like to thank Bret's dad whose Tivo©  
and love of MacGyver made this book possible.  
So blame him.*

## **Chapter I: Great Escapes**

Keep Your Cool: Escape from a Meat Locker

Take That, Indy: Escape from a Pit of Snakes

The Amazing MacGyver: Escape from a Straitjacket  
while Trapped Underwater

Escape from an Incinerator

Escape a Pack of Hunting Dogs

Escape from the Basement of a Collapsed Building

Escape from Being Blown to Kibbles and Bits

## **Chapter II: Car Troubles**

Make a Stick-Shift Car Drive Itself

Repair a Busted Brake Line While in a Moving Car

Fake a Flat Tire

Recharge a Car Battery with a Bottle of Wine

Lift Your Car with a Innertube

Repair a Broken Fuel Line with a Ballpoint Pen

A MacGyver Classic: Make an Arcwelder from a Car  
Battery and Pocket Change

## **Chapter III: Angus Macgyver: Superspy/**

### **Chemistry Teacher**

Make a Fire Extinguisher with the Contents of Your

Kitchen Cabinet

Stop an Acid Leak with a Chocolate Bar

Read the Contents of a Burned Sheet of Paper

Make Your Own Homemade Tear Gas

Make a Homemade Spectroscope

Create Your Own Homemade Fog

Develop Photos with Battery Acid, Ammonia, and

Orange Juice

Power a Radio with a Cactus

Use a Photographic Fixer as an Antidote and an Icepack

## **Chapter IV: Breaking and Entering (use only for good, not for evil)**

Crack a Safe with a Telephone Handset

Fool a Thumbprint Reader with Wax and Pool Chalk

Hotwire a Phone to Listen to a Call in another Room

Fool a Motion Detector with Only a Light Bulb

Bypass a Keypad Security Lock with a Pencil

Disarm a Laser Beam Alarm System

Fool a Motion Detector with Chemistry

Pick a Lock with a Swiss Army Knife

Break Into a Building the Cool Way

## **Chapter V: Party Tricks and Diversions**

Undress a Woman with a Paper Clip and Thread

Win Yahtzee Every Time: Make Buffed Dice

Make a Lie Detector with a Blood Pressure Cuff and an

Alarm Clock

Make Fake Blood with Drain Cleaner

Make a Soda Machine Shoot Soda Cans

Knock Out the Lights with Window Cleaner

Create a Magnet with a Iron Bar and a Fire Hydrant

Escape from a Boring Dinner Party

## **Chapter VI: Bombs and Booby-traps**

Make a Timebomb with a Glass of Water, a Cold  
Capsule, and Sodium Metal

Watch out Yogi Bear: Build Pinecone Landmines

Fend off Thugs with a Fire Hose: A Humorous  
MacGyver Classic

Make your Kitchen into a Death Trap!

Disarm a Missile with a Paperclip

## **Appendix: The Complete List of MacGyver's Cool Tricks (a.k.a. MacGyverisms)**

# Introduction

Who wouldn't want to be a little bit more like MacGyver? Smart and handsome, MacGyver led a life of excitement and adventure. Yet this is not why millions of Americans still find him intriguing today. No, it's because he could make a bomb out of household cleaning supplies.

In the seven years MacGyver was on the air, he managed to handle any predicament using intelligence, ingenuity, and a pocketknife. Most of his amazing tricks followed from the principles taught in high school science classes. While you might not be as resourceful as MacGyver in a pinch, by following the instructions in this book you can perform many of MacGyver's feats.

## Introduction

---

Here at the Rogues Inc. Labs we've always fancied ourselves to be like TV's MacGyver: brainy, resourceful, and easy on the eyes. We have Swiss Army Knives, personal supplies of duct tape, and cool mullet haircuts. And, we too, never manage to score, even with plenty of lovely ladies around. Imagine our excitement when our lord and master, Rogue captain Dean Moriarty, demanded that we recreate MacGyver's tricks to see if they would actually work. After a two-hour lunch, we eagerly prepared ourselves for a trial test of Mac's tricks.

First, we emptied the cafeteria cabinets at Rogues Inc. of all the common household supplies we could find. We then set to work creating arc welders, smoke bombs, and lie detectors.

Next, we rounded up some of the Rogues Inc. interns to recreate some of MacGyver's great escapes. We can still see the look on Etienne's face when we doused him with kerosene and tossed him into a pit of snakes. We probably should have warned him first. But as we testified in court: was it our fault he only understood French?

Fortunately, the kerosene trick worked with the snakes. In retrospect, we should have waited until Etienne was cleaned off before we tested out the cold capsule explosive trick. Lesson learned.

Some of MacGyver's tricks can be dangerous. Be careful and have fun. And please, don't get a mullet.



## **Top Eight Rope-Removal Tools**

1. Scroll saw (101 LOST AMADEUS)
2. Slimy toy goo (109 THE WALL)
3. Belt hook (112 MACGYVER'S WOMEN)
4. Metal grinder (121 BLIND FAITH)
5. Fish teeth (086 BLACK CORSAGE)
6. Sulfuric acid (130 THE COLTONS)
7. Broken glass (119 HIGH CONTROL)
8. Wine (058 THE ODD TRIPLE)



# Great Escapes

## How to Escape From a Meat Locker

*As Seen in Episode: 007 - Last Stand. MacGyver stumbles into a hostage crisis at a desert airstrip that armored-car robbers have taken over.*

### What You Need

- A meat locker
- A clumsy friend
- A cardboard box

### What You Do

1. Enter the meat locker, followed closely by your clumsy friend.
2. Scream “No!” as your clumsy friend accidentally closes the locker door.
3. Sit on the cardboard box and discuss the meaning of life.

4. Look upward and curse God for giving you such a stupid, clumsy friend.

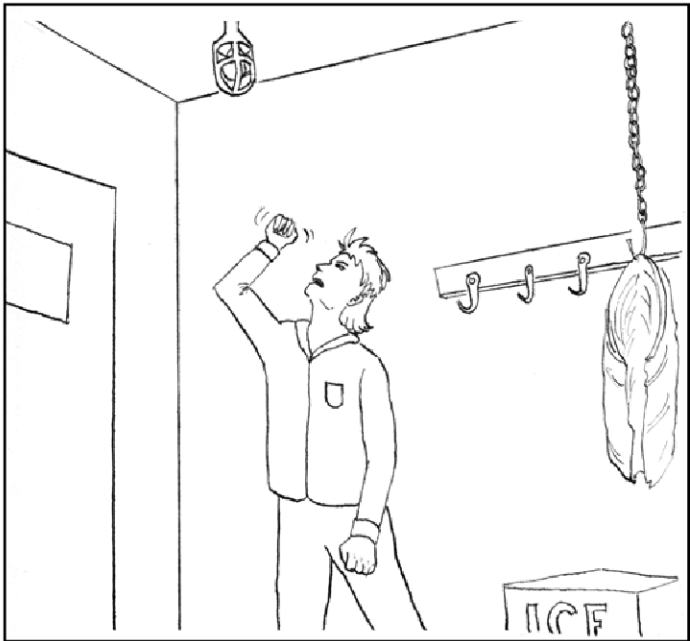

5. Note light bulb. Eureka!
6. Detach a meat hook from the bar hanging above you.

7. Use the eyehole of the meathook to unscrew the bolts around the doorknob.

8. Remove the door knob.

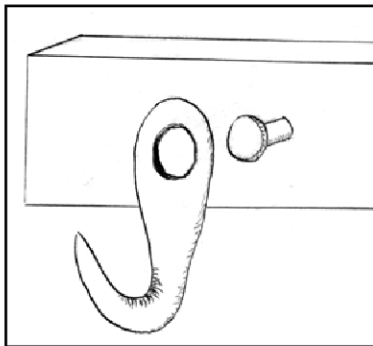

9. Rip a strip of cardboard from the box.

10. Fold the cardboard strip into a funnel shape.

11. Jam cardboard strip in the knob hole.

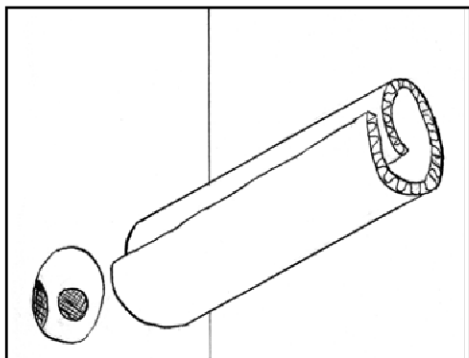

12. Pull a long pipe or bar from off the ceiling. The bar or pipe will be anchoring the meathooks.
13. Insert the end of the pipe or bar into the cardboard funnel. Hold the other end underneath the lightbulb.
14. Grab a chunk of ice.
15. Use the lightbulb to melt the ice so that it runs down the pipe or bar into the hole in the door.
16. Watch as the water from the melting ice flows into the door lock.
17. Wait as the water refreezes in the door lock causing it to break.
18. Kick open the door.
19. Escape to freedom and remind yourself to stop hanging out with sitcom characters.
20. Congratulate yourself on getting the sitcom character joke.

## Why It Works

Water is the only substance that expands when cooled. When it freezes, the molecules form a solid structure. The freezing water exerts outward force on the lock mechanism causing it to break. Once the lock breaks, a good kick will open the door.

## How to Escape from a Pit of Snakes

*As Seen in Episode: 089 - Halloween Knights. MacGyver's old nemesis, Murdoc, asks for his help in locating his sister, an innocent bystander that was kidnapped by Murdoc's employers, a cartel of assassins-for-hire.*

### What You Will Need

Kerosene lamp  
An entertainment lawyer

### What You Do

1. Open the kerosene lamp (battery-operated flashlights are so 1985) that you were using to navigate the underground tunnel.
2. Dump some of the kerosene around the ground area that you wish to be snake-free, being careful not to inhale the kerosene fumes.



3. Liberally splash more of the kerosene on your boots and pants so those slimy snakes avoid you altogether. A few dots behind the ears and you're ready to go clubbin' with Murdoc.
4. Contact your entertainment lawyer and hope that Indiana Jones doesn't sue you for theft of intellectual property rights.

## **Why It Works**

The odor of kerosene repels snakes and for good reason. Kerosene is a natural degreaser. Snakes are covered with a fine coating of oil. Kerosene would suck dry the snake's body oil, which probably feels the same as if someone poured hydrochloric acid on your hand. Not very pleasant. So when a snake smells kerosene, or more accurately tastes—a snake breathes with its tongue—they slither in the other direction. No word on kerosene's ability to tame a wild mullet.

## How to Escape from a Straitjacket while Trapped Underwater

*As Seen in Episode: 093 - Two Times Trouble. MacGyver tries to help an old friend who believes her jealous twin sister is trying to kill her.*

### What You Need

- A straitjacket
- A water tank (fish optional)
- A diabolical archenemy

### What You Do

1. Have your diabolical archenemy bind you in a straitjacket. Don't worry; if he's diabolical enough he'll have a straitjacket lying around his evil lair.
2. Exchange witty banter with your archenemy as he throws you in an empty water tank.
3. As water floods the tank, anxiously look around. How will you get out of this one?

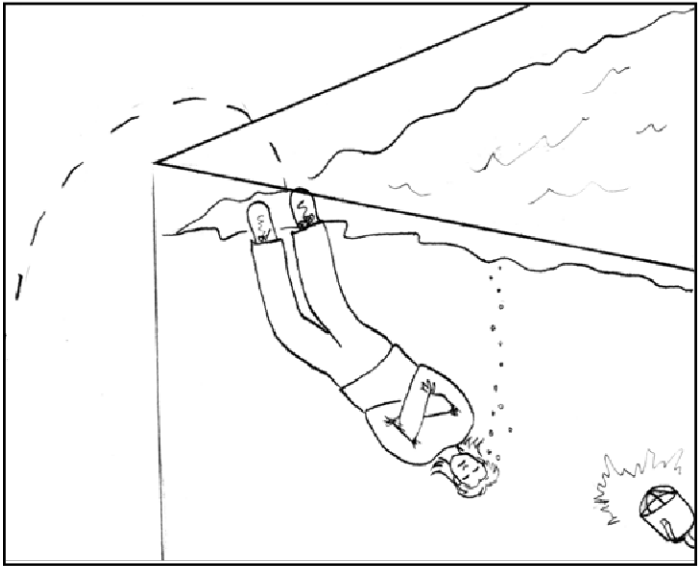

4. Go to commercial break. When you return from commercial break, note that the water that was once lapping up around your neck has returned to knee level.
5. Struggle helplessly as the water climbs above your head.
6. Swim towards the floodlight that is oddly present in the water tank.

7. Kick the floodlight, shattering its bulb. (Didn't see that coming, didya?)

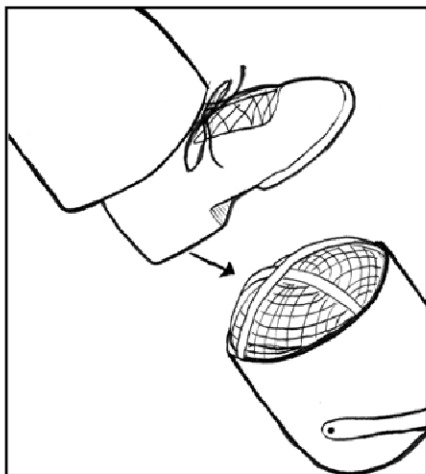

8. Rub your bound wrists against broken glass until it cuts through the straitjacket.
9. Wriggle out of the straitjacket.
10. Turn enormous wheel on the water tank door to open it.

11. Once the door opens, let the water pour you out into the hallway.
12. Take a deep breath.
13. Curse your archenemy who didn't even wait around to see you die. Sometimes it feels like he doesn't care about you at all.

### **Why It Works**

It happened on TV. This scenario is one of those rare incidents on *MacGyver* where fiction bears little or no relation to fact. Who can swim with a straitjacket on? Who puts floodlights in water tanks designed for killing do-gooders?

## How to Escape From an Incinerator

*As Seen in Episode: 116 - Squeeze Play. Mac defends a former player's daughter being blackmailed by a baseball memorabilia-counterfeiting ring trading on her father's name.*

### What You Need

An incinerator (with a glass window)

A metal rod

A piece of thread

### What You Do

1. Fall asleep in a pile of scrap metal. *Author's note:* if you have trouble falling asleep in the scrap heap, we recommend a little Jack Daniels in a snifter. Keep drinking until you pass out.
2. Wake up to discover yourself in an incinerator.

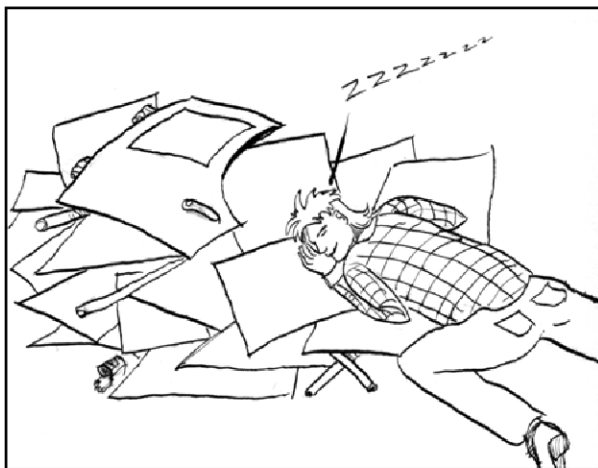

3. Grab a metal rod from the scrap metal in the incinerator.
4. Smash the incinerator's window with the rod.
5. Use the rod to push the incinerator's lever to OFF.
6. Breathe a sigh of relief.
7. Pull a long piece of thread off your shirt.
8. Tie the thread in a loop.

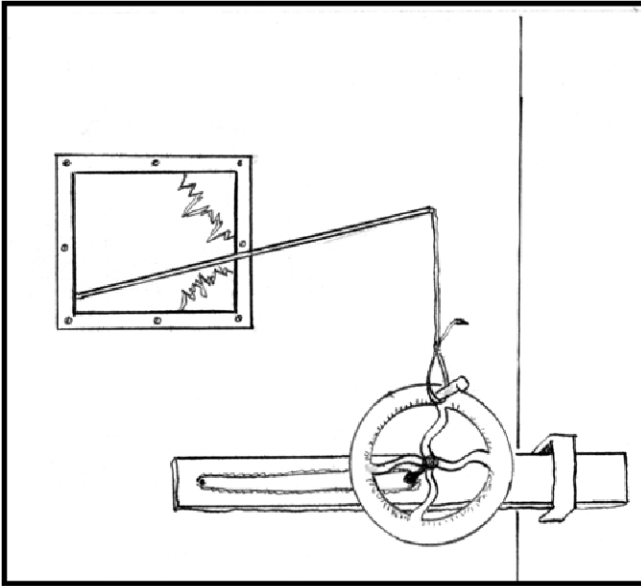

9. Hang the thread on the end of the rod.
10. Fish with the rod and thread until you snag the incinerator latch.
11. Unlatch the incinerator door and open the door.
12. Escape the incinerator and curse your damn narcolepsy/drinking problem.

**Why It Works**

Definitely do not try this one at home. Odds are that you will be a pile of burnt toast before you will be able to shatter the window with a metal rod. Just another reminder that MacGyver wasn't just smart; he was also a television character.

## How to Escape from a Pack of Dogs

*As Seen in Episode: 103 - Rush to Judgment. MacGyver risks judicial displeasure when he breaks jury sequester to investigate the scene of a racially charged murder, and discovers evidence that drastically alters the interpretation of the facts.*

### What You Need

A ravenous pack of hunting dogs  
A bottle of perfume  
A mannequin  
An evil shopping mall

### What You Do

1. Go to the nearest evil shopping mall to look for a gift for Pete's birthday.
2. Run! It's a trap. Guard dogs are on your trail.



3. Take the bottle of perfume you bought for Pete and spill it all over the floor. The odor of the perfume will cover your scent.
4. Run to the nearest clothing store.
5. Undress a mannequin. Pray that it's Kim Cattrall.
6. Take off your clothes.

7. Exchange your clothes with the mannequin.
8. Dress the mannequin in your clothes. Doesn't it look stylish in that flannel shirt and brown leather jacket? Now, the dogs will follow your scent to the mannequin and think it's you. Silly dogs.

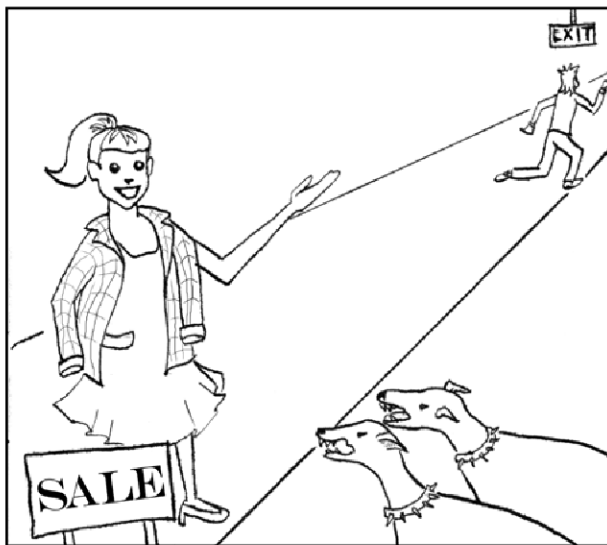

9. Sneak out the exit.
10. Wait outside for the chopper that will inevitably come to your rescue just when you need it.

## **Why It Works**

A dog may have a great sense of smell, but it is also really stupid.

Dumping the perfume effectively creates a very powerful odor temporarily masking the equally powerful scent of the human body. Unless you are an Eastern European man, in which case nothing will cover up your stench, oops, scent.

Fortunately, Fido and his friends can't immediately tell if the mannequin is you or not. After all, it smells like you, it's vaguely shaped like you, therefore it must be you.

## How to Escape From Beneath a Collapsed Beam

*As Seen in Episode: 001 – Pilot. Mac is asked to rescue scientists in an underground lab guarded by a deadly security system.*

### What You Need

A working firehose

A collapsed beam

A person, trapped under the beam, with only minor physical injuries

### What You Do

1. Tie a knot in the end of the hose.
2. Thread the hose underneath the collapsed beam.
3. Turn on the water.
4. Watch as the water inflates the hose and lifts the beam.

5. Watch the slightly injured friend wince in pain as you pull her to safety.

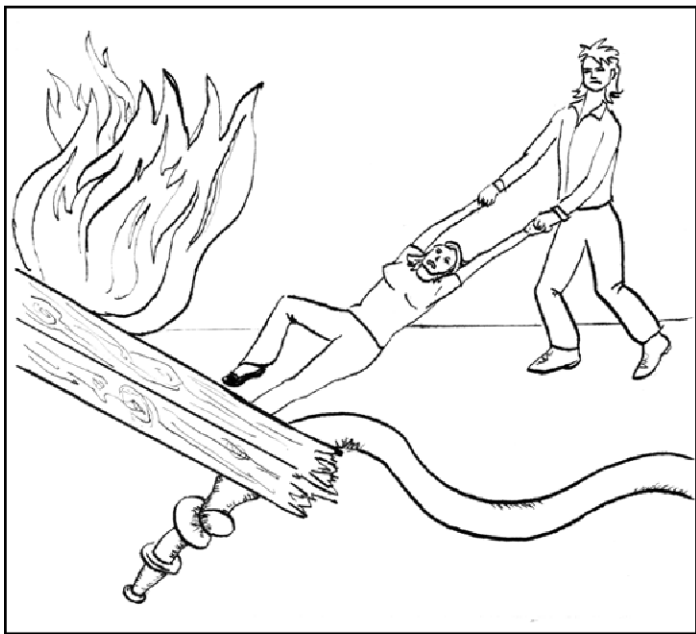

6. Cross your fingers and hope that your friend will “reward” you after a few drinks in the Phoenix Foundation’s wet bar.

## Why It Works

The knot in the firehose prevents the water from being released. Because it cannot be released, the water pushes outward on the hose and causes the hose to bulge. The pressure of the water should be enough to lift an obstacle lying on top of the hose, even a construction beam. Water pressure inside a firehose typically ranges from about 300 to 1200 pounds per square inch (PSI).

However, you are limited by the diameter of the hose, so you can only lift something a couple of inches. So guys, when all you need is an extra couple of inches, a firehose can be your best friend.

## How to Escape from Being Blown to Kibbles and Bits

*As Seen in Episode: 130 - The Coltons. Mac's old friends, the bounty-hunting Colton brothers try to find a young woman who's the only witness to a Chinatown murder.*

### What You Need

Sulfuric Acid (WARNING: VERY DANGEROUS TO TOUCH, BREATHE, OR MOCK IN POLITE COMPANY)

A cardboard tube

A ruler

A bomb

A super-intelligent trained dog that will appear whenever you're about to be blown to bits (we suggest Lassie)

A cookie

### What You Do

1. Set timer on the bomb to five minutes. Anything higher will dampen the suspense.

2. Tie your hands behind your back. Make sure the knot is tight. You don't want to escape too easily.
3. Wait for the dog to arrive.
4. Tell the dog to bring you the bottle of sulfuric acid you placed just out of reach. Good for you, challenge is important to character development.
5. Kick a ruler off a nearby table.
6. Watch the ruler flip through the air and land on a cardboard tube. Wow! The ruler is perfectly centered on the tube. Now you can use it as a seesaw to fling the bottle up to your hands.
7. Tell the dog to put the bottle of acid on the far end of the ruler. At first he'll pretend not to understand, but don't worry, he's just being smart. He understands that he needs to create suspense for the audience.
8. Stomp on the near end of the ruler to make the bottle fly through the air, arcing behind you into your bound hands.

9. Fantasize about all those amazing slapshots you would have made if you'd only gone into professional hockey instead of problem solving.
10. Open the bottle and let the acid pour onto the rope.
11. Wait as the acid melts through the rope and not through your hands.
12. Break the ropes and run.
13. Give the cookie to the dog. He deserves it.

### **Why It Works**

It's the Lassie gene. Dogs that are on television shows all share a specialized gene that allow them to act as obvious plot devices while allowing the audience to suspend disbelief. And they're cute as well, though we attribute this largely to makeup. Rumor is that the dogs are bred in a special compound in Burbank, California by a team of Hollywood writers using frozen sperm salvaged from Lassie himself. Yep, Lassie was a boy. A good boy.

## **Top Seven Ways to Boobytrap a Car**

1. Loosen Lugnuts (009 PRODIGAL)
2. Drain the radiator (009 PRODIGAL)
3. Let air out of tire with nail (011 NIGHTMARES)
4. Potato on tailpipe caused car to backfire  
(021 A PRISONER OF CONSCIENCE)
5. Took distributor cap from bad guys car  
(063 ENDANGERED)
6. Sock over the tailpipe, so car couldn't start  
(075 THE BATTLE OF TOMMY GIORDANO)
7. Tied car to garbage dumpster with hose  
(077 RUNNERS)



## **Car Troubles**

## Make a Car Drive Itself

*As Seen in Episode: 003 - The Gauntlet. MacGyver retrieves a top-secret map, and uses it to escape his pursuers in the desert. Then, Mac helps a reporter with evidence linking a general to an illegal arms dealer get out of a Latin American country.*

### What You Need

Duct tape  
Belt

### What You Do

1. Loop belt through the steering wheel and around the gear shift.
2. Tape the gas pedal to the floor.
3. Start the car.
4. Put the car into DRIVE. Pulling back the gear shifter will cause the belt to tighten.

The tension on the belt will keep the steering wheel straight.

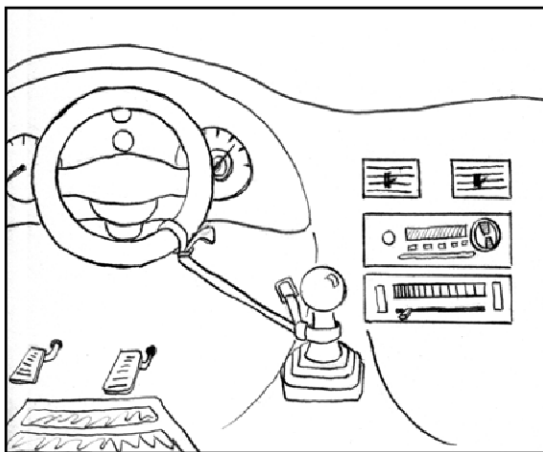

5. Jump out.

## Why It Works

If you require an explanation for this one, please email us at [IAMANIDIOT@macbook.com](mailto:IAMANIDIOT@macbook.com)



## How to Repair a Busted Brakeline while in a Moving Car

*As Seen in Episode: 015 - The Enemy Within.  
MacGyver must protect a defector who can identify  
the killer of three agents.*

### What You Need

A speeding car with a busted brakeline  
Someone to drive the speeding car  
A carload of thugs on your tail  
Your MacGyver knife

### What You Do

1. Wait until the car you're in reaches a speed that will be exciting for the television audience.
2. Ask your passenger to take over the steering wheel. What! No passenger! See the entry: *How to Make a Car Drive Itself.*

3. Pop the hood. Because the car is speeding, the wind will rip off the hood when it opens. Hopefully, the hood will take out a couple of pursuing thugs as well.

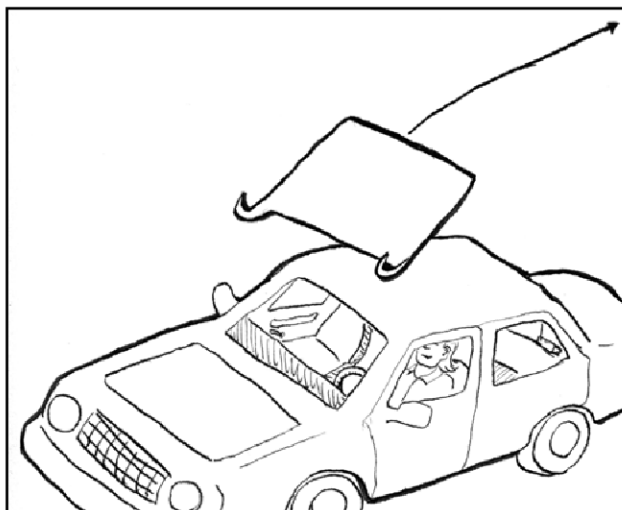

4. Climb out onto the front of the car.
5. Locate cut brake line. It will be leaking brown fluid.
6. Pray that the busted line is the outtake line and not the intake line.

7. Open the brake fluid tank. It should be empty.
8. Locate the power steering fluid tank. Find the power steering line that leads out from the power steering fluid tank. If you can't figure out which line to cut, take a chance: you're going to plummet off a cliff before the next commercial.
9. Cut the power steering fluid line.
10. Insert the power steering fluid line, which should now be spewing fluid, into the brake fluid tank. This should provide enough fluid to the brakes to stop the car. However, the power steering fluid, as any mechanic will tell you, should never be used as brake fluid. However, most mechanics probably doesn't get into many high-speed car chases in the former East Germany.

### **Why It Works**

It doesn't. In a hydraulic braking system, the brake fluid transfers the force applied to the brake pedal to the brake cylinder, causing the brake pad to press

against the tire. The friction causes the car to stop. If the brake line is cut, air is allowed into the system and prevents the transfer of pressure. MacGyver's solution of replacing the fluid does not work because it does not account for the air in the brakeline.

Why does the air cause a problem? Brake fluid cannot be compressed, which means you cannot force it to become any smaller. If you push on the brake fluid, it, in reaction, pushes onto something else with equal pressure. Therefore, brake fluid is an excellent medium to transfer pressure. Air, however, can be compressed. Air, if you press on it, will become smaller; therefore it does not transfer pressure very well. The air will not transfer the force applied to the brake pedal to the brake cylinder, and once air gets into the system it is very difficult to get out. So it seems, on this trick, MacGyver is full of hot air.

## Fake a Flat Tire

*As Seen in Episode: 003 - The Thief of Budapest. MacGyver retrieves a stolen horse and gets picked up by a chopper. Then, in Budapest, a gypsy steals a watch containing the microfilm MacGyver was supposed to receive from a Russian agent.*

### What You Need

Light bulbs  
A board  
Duct tape  
A car

### What You Do

1. Tape the light bulbs alongside the wide part of the board.
2. Hide in the bushes near a road.

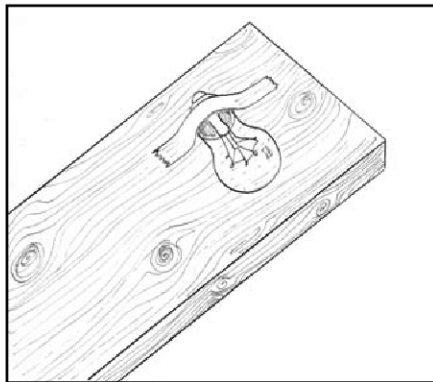

3. Place the board with the light bulbs on the ground. Make sure the light bulbs are on the bottom of the board.
4. Wait until the target car drives by.
5. Stomp on the board causing all the light bulbs to shatter. It will sound like a tire has blown out. The car will stop.
6. Wait until the driver comes out to check the tires.
7. Ambush him and steal the car.

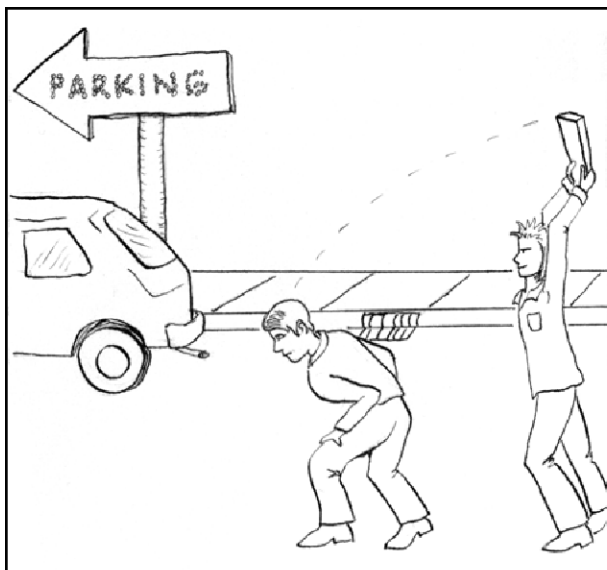

### Why It Works

If you've ever heard a tire blowout, then you know it's a loud popping noise, often so loud it is startling. Breaking, or more accurately depressurizing, a light bulb sounds very much like a tire blowout. The inside of a light bulb is

a vacuum, the complete absence of air. When the bulb is broken, air instantly rushes in to fill the vacuum. The quick influx of air creates the intense popping sound that may be mistaken for a tire blowout. This should not be surprising because in a tire blowout, the same change in air pressure occurs, only in reverse. Because the air in the tire is under pressure, when the tire wall is punctured the air seeks to escape the outside of the tire where the pressure is less. The rapid change in air pressure causes the popping sound.

## Recharge a Car Battery with a Bottle of Wine

*As Seen in Episode: 029 - Jack of Lies. Jack Dalton needs help freeing a “botanist” being held by drug smugglers, and she turns out to be an old friend of Mac’s.*

### What You Need

Wine (preferably red)

A dead car battery

### What You Do

1. Unscrew the caps on the battery indicating positive and negative.
2. Pour wine into the battery.
3. Replace the caps and start the engine.

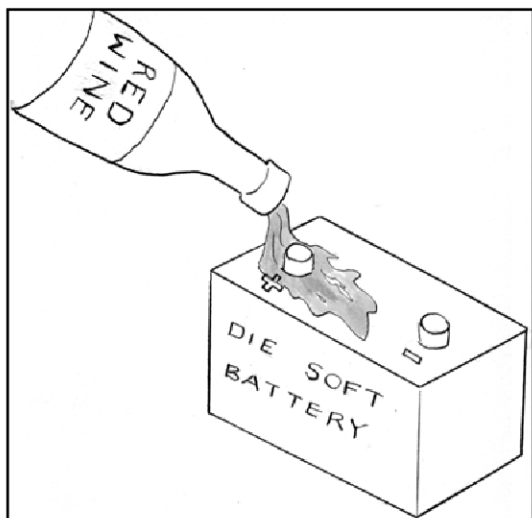

4. Enjoy your freshly charged battery.

### Why It Works

If you look at car battery, you'll notice it has two large terminals with plastic caps. One terminal is marked (+), or positive, while the other is marked (-) negative. Since electrons are negatively charged, they are attracted to the negative terminal of the battery. Pouring any acidic liquid in the battery allows the electrons to flow freely

between the negative and positive terminals providing energy to operate the car's motor.

Apparently, Mac is not a wine connoisseur. For this to work, our top-notch research team has determined that his wine was mostly vinegar. Vinegar's highly acidic state would make it a better solution for the electrons to travel through.

So save your wine and only do this if 1) you really need that car to start or 2) you want your drunk uncle to electrocute himself trying to slurp from the battery case.

## How to Lift a Car with an Innertube

*As Seen in Episode: 111 - Harry's Will. When Mac tries to claim the station wagon left to him by his late Grandpa Harry, it starts a strange chase that leads him to an ex-con with a dream of running a restaurant, a soup kitchen in need of money, and a gang of crooks out for themselves.*

### What You Need

A deflated innertube

An air pump

An old car that needs lifting

An understanding of air pressure ( $PV=uRT$ )

### What You Do

1. Place the deflated tube underneath the car in the same place as you would a car jack.
2. Inflate the tube to its maximum pressure.

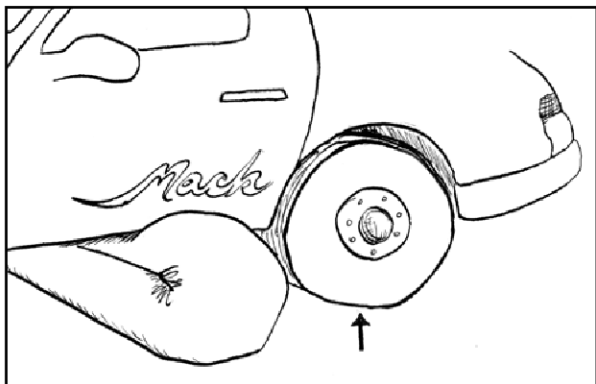

3. Watch as the car rises off the ground.
4. Marvel at the wonders of air pressure science.

### Why It Works

Air contains tons of microscopic molecules, and just because you don't see them doesn't mean they aren't having an effect on you. These microscopic molecules have mass just like anything else—a rock, for instance.

So, picture air as a bunch of really tiny rocks pushing you. Normally, these rocks are far apart and we don't

notice them. However, when you force a lot of air into a small space, a tire, for instance, these little rocks (molecules) are pushed really close together. Because these rocks are an antisocial bunch they do not want to be that close together. As a result they push outward on the wall of the tire in an attempt to get away from each other. And they can push really hard. The average pressure in a truck tire can range from 30 to 100 PSI. The force of the molecules pushing outward on the tire wall inflates the tire and is able to lift a car on top of the tire.

In fact, the pressure exerted on you by these molecules, is part of what is keeping you from being able to dunk a basketball or jump your dirt bike like Evil Knievel. At sea level the air in the earth's atmosphere is pressing down on you with a force of 14.7 pounds per square inch (PSI). However, the higher you go the more relief you get. Air pressure decreases at higher altitudes. When one is in jet plane flying at approximately 30,000 feet, the PSI is much lower, closer to 5 PSI. If only your high school gym was as high as the top of Mt. Everest!

## **A MacGyver Classic: The Fifty-Cent Arcwelder**

*As Seen in Episode: too many to mention.*

### **What You Need**

A car battery  
Jumper cables  
Fifty cents (two quarters)

### **What You Do**

1. Place a quarter in each alligator clip at the end of each jumper cable.
2. Attach the other end of the jumper cables to the car battery.
3. Grasp the rubber grips of the jumper cables on the end attached to the quarters.
4. Slowly bring quarters together, but do not let them

touch. An arc of electricity will shoot between the two coins.

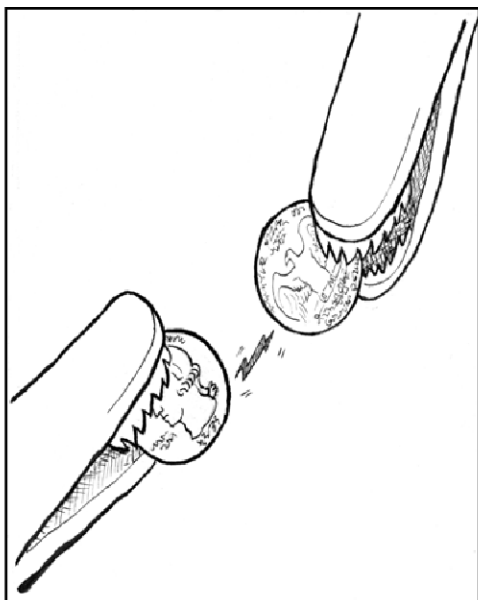

5. Use this electric arc to make necessary welds.

## Why It Works

When you attach the jumper cables to the car battery you create a circuit. Energy from the positive terminal of the battery wants to return to the negative terminal of the battery. As long as the ends of the jumper cables do not touch, the circuit is open. By bringing the ends of the jumper cable near one another, you allow electricity to jump from one cable to the other, completing the circuit. The quarters, because they are mostly copper (over ninety percent), conduct electricity easily. They offer an easy path for the electricity to make its jump. Even better, because quarters are clad in nickel—the sides are made of nickel while the core is copper—the electricity passes through the copper core focusing the electrical discharge towards the thin edge of the quarters. This narrows the point of release, creating a more powerful electrical arc. This is why the edge of the quarter offers an infinitely narrow, and ideal, jumping point for the electric current.

## How to Repair a Busted Fuel Line with a Ballpoint Pen

*As Seen in Episode: 015 - The Enemy Within. MacGyver must protect a defector who can identify the killer of three agents.*

### What You Need

Car  
Severed fuel line  
Ballpoint pen  
Duct tape

### What You Do

1. Disassemble the pen. This can be easily done by pulling the tip of the pen from the body.
2. Locate the severed fuel line. The fuel line will be located to the right of the air filter and can be spotted by the puddle of gas forming on your driveway.

3. Insert each end of the severed fuel line into the hollow pen sheath.
4. Liberally apply duct tape to insure that there will be no leakage.

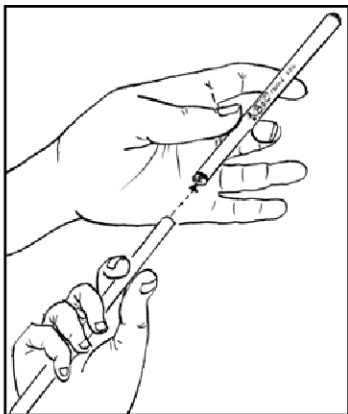

5. Enjoy your drive, but go easy on the gas--this is only a temporary fix. Unless you own an orange Dodge Charger named the General Lee, in which case the laws of physics, auto repair, and that thing about not marrying your cousin do not apply to you.

### Why It Works

The pen sheath acts as a replacement tube for the section of the severed fuel line. The duct tape ensures that leakage will be minimal. In practice, any sturdy tube will function equally as well.

## **Top Five Most Useful Chemicals**

1. Hydrochloric Acid
2. Sodium thiosulfate
3. Acetic Acid
4. Ammonia
5. Alcohol

CHEMISTRY ROOM 101

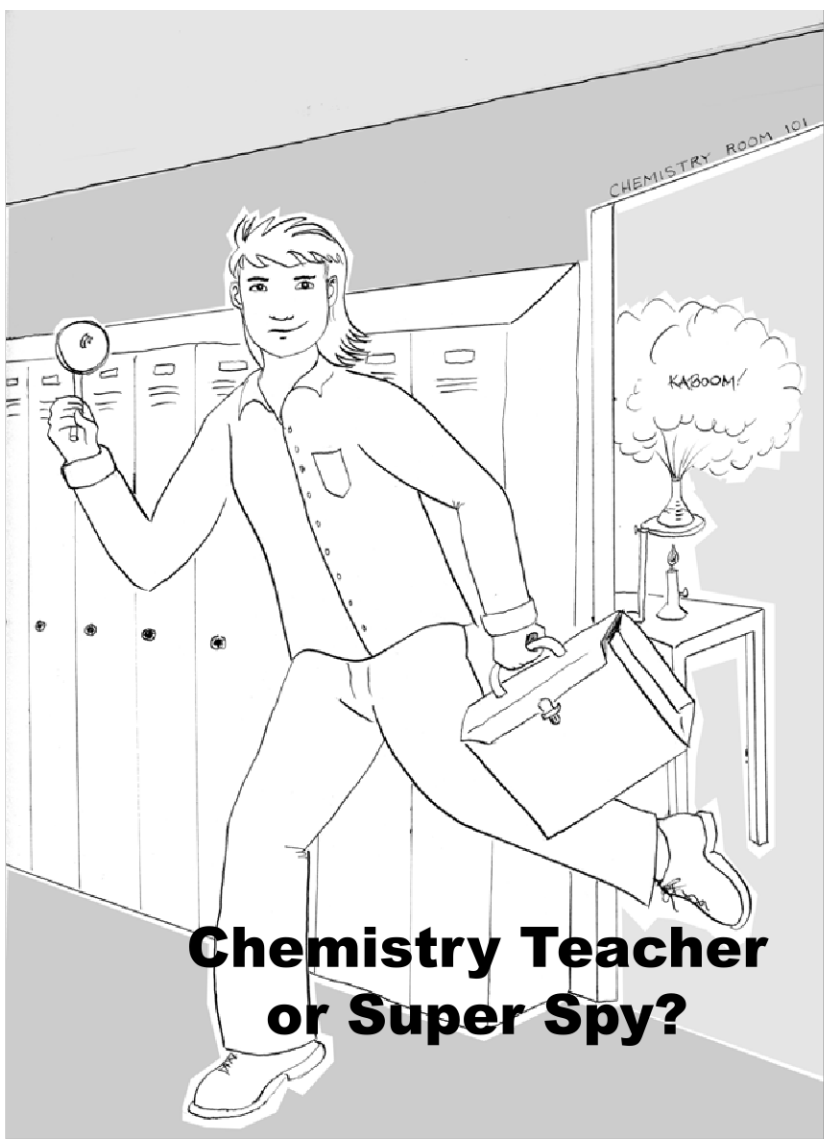

**Chemistry Teacher  
or Super Spy?**

## Make a Fire Extinguisher from the Contents of Your Kitchen Cabinet

*As Seen in Episode: 132 -- Good Knight MacGyver. A bonk on the head sends MacGyver back in time to King Arthur's Court, where his futuristic ways are a threat to Merlin's magic, but they also might prove that the magician didn't try to do in the King.*

### What You Need

Large plastic bottle with a narrow opening  
Vinegar  
Baking soda  
A fire

### What You Do

1. Fill bottle  $\frac{3}{4}$  full with baking soda.
2. Pour vinegar into the bottle.
3. Aim the bottle mouth toward the fire. Bubbly liquid will shoot out of the mouth of the bottle.

After enough bubbly liquid reaches the flames they will die out.

4. Glow in the satisfaction that Mom's meat loaf is saved.



## Why It Works

Fire extinguishers work by removing one of the critical ingredients for a fire—oxygen. When vinegar is combined with baking soda, the two react and produce carbon dioxide gas or  $\text{CO}_2$ . This type of reaction is known in chemistry as an acid-base reaction, and the vinegar (the acid) and baking soda (the base) model is a high school chemistry classic:

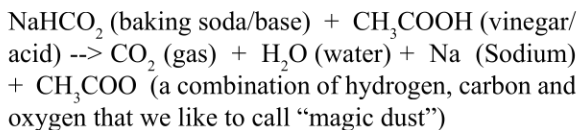

The  $\text{CO}_2$  gas produced by this reaction has a heavier molecular weight than does the surrounding air, which is comprised primarily of nitrogen and oxygen, so the  $\text{CO}_2$  sinks into the bottom of the room. As the reaction continues, more and more carbon dioxide gas is produced and slowly fills up the room, displacing the oxygen. When the level of carbon dioxide has risen to the level of the flame, the flame will go out from lack of available oxygen. As mother always said: “If I’ve told you once, I’ve told you 1,000 times any combustion-reaction (fire) requires a primary oxidant (oxygen) in order to work.” Yeah, she’s a special lady, our mom.

## How to Stop an Acid Leak with a Chocolate Bar

*As Seen in Episode: 001 – Pilot. When the Government has an impossible mission, it calls on MacGyver, a laid-back former special-forces agent. The mulleted-one is tasked to rescue scientists trapped in an underground lab protected by a deadly security system.*

### What You Need

A leaking container of sulfuric acid  
A chocolate bar

**WARNING:** If sulfuric acid touches your skin, it will burn you.

### What You Do

1. Remove chocolate bar from its wrapper.
2. Rub chocolate bar onto the leak.



3. Wink at your friends as the chocolate reacts with the acid to form a gluelike substance, effectively plugging the leak.

### **Why It Works**

It's is a relatively simple chemical reaction. The sugar in the chocolate bar reacts with the sulfuric acid to create a new substance with the properties of glue.

The reaction:

Sugar ( $C_{11}H_{22}O_{11}$ ) + Sulfuric  
Acid ( $H_2SO_4$ ) = Thank God I'm not  
dead (actually, carbon) (C)

When sulfuric acid encounters sugar, it removes the water ( $H_2O$ ) from the sugar, leaving the carbon. An example of carbon is the black ashes that are left when you burn wood in a fireplace. The dehydrated chocolate bar/carbon acts like a sticky putty and plugs the holes, preventing the acid from continuing to leak.

### **Would It Really Work?**

Unlikely, since the acid will probably be issuing from the leak with a fair amount of force. Picture trying to put chewing gum on gas leak. However, if the acid is only trickling out, then Mac might have found another excuse for you to carry around a chocolate bar. In any case, MacGyver would have needed a lot of chocolate to plug those leaks: enough chocolate keep Oprah on a sugar high for the next decade.

## Read the Contents of a Burned Sheet of Paper

*As Seen in Episode: 096 -- Live and Learn. MacGyver reaches out to a promising high-school student as part of a Phoenix Foundation mentor program, despite a cynical teacher and the youth's no-nonsense father.*

### What You Need

Paper (freshly burned)  
Glycerol  
Water  
Wooden sticks

### What You Do

1. Place the burned paper carefully on a clean sheet of paper.
2. Mix equal-parts glycerol and water.
3. Pour the mixture into a plastic spray bottle.

4. Spray the glycerol and water mixture over the burned paper.
5. Carefully smooth the burned piece of paper with wooden sticks.
6. Hold the paper in front of a lightbulb.



7. Read the writing on the paper.

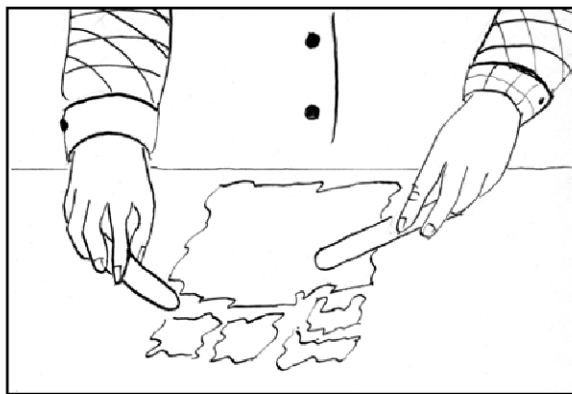

8. Admire your luck that a substance as cool as glycerol was sitting around an office.

### **Why It Works**

By spraying a mix of glycerol and water on the paper, MacGyver caused the burned paper to absorb water and expand, allowing him to read it.

The glycerol acts as a moistening agent to keep the paper from crumbling into ash while you're smoothing it out. The grease in pencil lead does not burn easily, so any writing in pencil will remain fairly unscathed by the flame. And since the grease also repels water, it won't be damaged by the water-glycerol solution. The water will make the paper semi-transparent, meaning that it will also light to pass through it, however the grease will not be transparent. By holding the wet paper in front of the light, you can see the outline of the writing.

Glycerol, by the way, is found in sports drinks AND high-powered explosives like nitro-glycerin. Any wonder that glycerol is in the Chemistry Hall of Fame? (Yes, there is such thing).

## How to Make Homemade Teargas

*As Seen in Episode: 054 - Blow Out. Political terrorism hits close to home when Nikki, who accidentally witnessed a terrorist bombing, is targeted by the bomber, who fears she can identify him.*

### What You Need

Hot water bottle  
Spices (preferably chili powder AND/OR red pepper)  
Baking soda  
Vinegar  
Your MacGyver knife

### What You Do

1. Pour spices into hot water bottle.
2. Pour baking soda into the hot water bottle.
3. Pour vinegar in the hot water bottle.
4. Close bottle. The bottle will expand rapidly.

5. Approach the villain.
6. Pierce bottle with knife.
7. Smile innocently while the villain screams in pain as hot spices burn his eyes.



8. Go save this episode's female victim/Mac's old flame.

### Why It Works

When vinegar and baking soda are combined, they form carbon dioxide. The carbon dioxide inflates the hot water bag. The effect is similar to shaking up a can of soda. Piercing the bottle causes a forceful release of the  $\text{CO}_2$  gas along with the painful (and delicious) spices. A little cumin in your eyes, Mr. Terrorist?

## How to Make a Homemade Spectroscope

*As Seen in Episode: 113 - Bitter Harvest. MacGyver picks up where a murdered farm-worker left off by investigating a grower's possible use of illegal pesticides.*

### What You Need

Your MacGyver knife

A glass

Nail polish remover

Lamp

Sunglasses (with polarized lenses)

A sample of the suspect pesticide to test

An encyclopedic knowledge of chemistry

### What You Do

1. Scrape some small pieces of the pesticide into the glass. The smaller, the better.
2. Pour in some nail polish remover.

3. Hold the glass over the lamp.
4. Look through the polarized lens at the sample.
5. Use your encyclopedic knowledge of chemistry to identify the sample based on the colors you see through your homemade spectroscope.



## Why It Works

A spectroscope is used to identify elements based upon their colors. Different elements reveal different colors when they are heated.

In this case, MacGyver's polarized sunglasses (aviator style optional) act as a simple *diffraction grating* spectroscope. This type of spectroscope separates light by preventing certain wavelengths of light from passing through the glass, allowing Mac to observe the color of an element when light is passed through it.

The nail polish contains acetone, a commonly used solvent, which dissolves the sample. Passing a light through the dissolved sample allows Mac to see if the pesticide contains a certain color, which he is able to identify as illegal.

## Would It Work?

Nah. Each element appears as a slightly different color. Most pesticides are complex chemical chains, meaning that Mac would have to know each color in that chemical compound. On the other hand, if it

were a simple element like potassium, he would see a yellowish hue, and would know immediately that the bad guy is guilty of environmental evil. However, in order to determine the complex array of elements likely to be present in his sample Mac would likely need a spectroscopy color guide and much better spectroscopy. Aviator sunglasses, while cool, do not filter light perfectly.

## How to Create Homemade Fog

*As Seen in Episode: 043 - D.O.A. MacGyver. An amnesiac MacGyver is hunted by terrorists who believe he knows of their plan to assassinate U.S. military figures with an explosive device.*

### What You Need

Muriatic acid or hydrochloric acid

Ammoniac

Safety goggles

**WARNING:** Both ammonia and muriatic acid, are hazardous if you touch, breathe, or ingest them.

**BE CAREFUL:** no chugging contest with your roommates.

### What You Do

1. Put on your stylish safety goggles.
2. Pour the ammoniac and the muriatic acid into separate buckets.

3. Splash the ammoniac onto the floor.
4. Splash the muriatic acid onto the puddle of ammoniac.
5. Hold your breath and watch as white fog fills the room.



## Why It Works

When ammoniac reacts with muriatic acid it creates a white ammonium chloride fog:

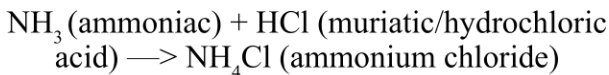

Ammonium chloride is a white colored substance that is also produced in volcanic eruptions and apparently used in the manufacture of livestock feed (yum!). In practice, great care should be used when recreating this trick because the fumes that are created will be very toxic.

To create a safe, fun, homemade fog, try pouring water over dry ice. After all, muriatic acid isn't sold in ice cream parlors, but then again neither is dry ice.

## How to Develop Film with Orange Juice

*As Seen in Episode: 070 - The Survivors. MacGyver and Pete find a crashed DEA plane while on a rugged wilderness survival test and have to flee from the drug smugglers responsible for downing the plane.*

### What You Need

Orange Juice

Battery Acid (diluted)

Ammonia

Tongs or gloves

Drug smugglers who have left incriminating film behind.

### What You Do

1. Find your neighborhood dark room (or turn off the lights in your closet, genius).
2. Soak the film in orange juice for about ten minutes.

3. Put the film out of the orange juice.
4. Rinse film with ammonia.
5. Post any pictures with naked women on the Internet.

### **Why It Works**

The film in your camera records the visible light reflected from the objects in the camera's field of view. Chemicals are then used to extract that image, either by you in a darkroom or by the pimply 18-year-old teenager at the Photomat.

MacGyver's film, like all film, consists of an emulsion painted onto clear plastic or glass. An emulsion is gelatin solution containing a group of tiny crystals known as silver halides. These silver halides are extremely sensitive to light. When you click your camera shutter you open a lens, allowing reflected light off of the subject of your photo to be captured by those amazing silver halide crystals. The result is called a latent image.



Chemicals, called developers, are then used to make the latent image visible. When developing film, the goal is to convert the silver halides into metallic silver, using a series of complex and offsetting reactions with acids and bases. Bases are bitter-tasting substances like soap while acids are corrosive, sour tasting substances like lemon juice. It's a somewhat complex chemical process to go through just to get a photograph of someone's eyes closed! Oh, and did we

mention this must all be done in complete darkness?

MacGyver used the orange juice as a developer. As everyone knows, orange juice contains a lot of Vitamin C. Vitamin C is actually an acid, ascorbic acid. Ascorbic acid is a very good developer if combined with an alkaline, baking soda for instance. MacGyver skipped this step. Some commercial developer chemicals use a form of ascorbic acid as their primary ingredient. So MacGyver is on the right track.

After the developer has taken effect, and it might be a while just using orange juice, the chemical conversion process must be stopped. The step is called the stop bath. Rinsing the film with water should be sufficient to stop the process.

Next, a fixer is used to dissolve the undeveloped silver halides. If one does not dissolve the undeveloped halides then when your film is exposed to light, it will go entirely black! As a fixer, MacGyver used ammonia, which is a very strong base.

Here's the chemical formula:

Developer (Orange Juice (C<sub>2</sub>H<sub>4</sub>O<sub>2</sub>))  
+ Fixer ( Ammonia (NH<sub>4</sub>))  
= Processed Film

Hey, we left out the battery acid! And MacGyver should have, too. It was unnecessary. Battery acid, also known as sulfuric acid is sometimes used a part of a bleaching agent to reduce the contrast in the developed film to achieve an artistic effect. If you ask us, the last thing you want to be doing is being artsy with sulfuric acid.

And for all you caffeine addicts, feel free to substitute coffee for orange juice. The caffeic acid, we couldn't believe either, makes an excellent developer. Just remember to stir in a spoonful of baking soda before you dip the undeveloped film.

## How to Power a Radio with a Cactus

*As Seen in Episode: 018 - Ugly Duckling. Black market thugs are after a 15-year-old genius, who is the only person capable of fixing a stolen missile's guidance system.*

### What You Need

A cactus  
A galvanized nail  
A small radio  
Your MacGyver knife

### What You Do

1. Open the radio's plastic case.
2. Find the power leads. They will be a pair of black and red wires connected to the battery terminals. See diagram.
3. Cut the wires away from the battery terminals.
4. Strip the plastic coating from the wires to reveal the copper inside.

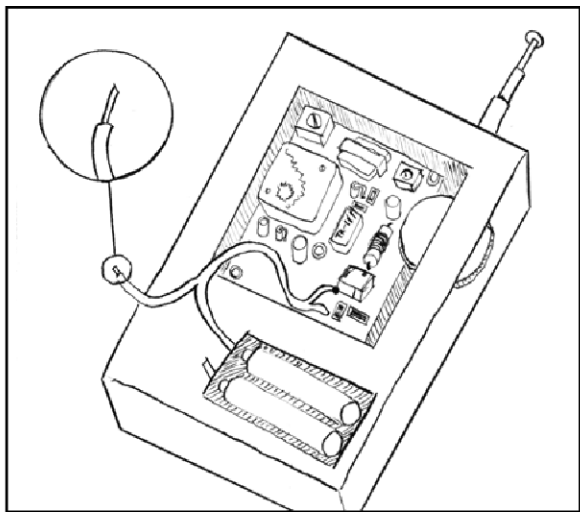

5. Wrap the copper part of the black wire around the nail.
6. Insert the nail into the cactus.
7. Insert the copper part of the red wire into the cactus.
8. Turn on the radio. Congratulations! You're operating on cactus power.



### Why It Works

The cactus acts as a natural battery, providing power to the radio. Both batteries and cacti contain chemicals known as electrolytes, which are comprised of charged particles called ions. The nail and the copper wire act as electrodes. The chemical reaction between the electrolyte and the electrodes create electricity, which makes the radio work.

This trick doesn't just work with cacti, many other objects contains electrolytes: lemons, bananas, even your own body! Of course, this trick only works if the device you are trying to use does not require too much electricity. So you'd better not count on cacti to power that new Margarita Mixer.

## How to Use a Photographic Fixer as an Antidote and as an Icepack

*As Seen in Episodes: 074 - Fraternity of Thieves. MacGyver learns that Pete's son may be responsible for the theft of a Phoenix Foundation technology system.*

*135 - Split Decision. MacGyver's boxer buddy fights to retain custody of his daughter, but some bad bookmakers want him to take a dive in his comeback bout.*

### What You Need

Sodium Thiosulfate (A photographic fixing chemical)

Prussic Acid (Hydrogen cyanide)

Water

A cup

A Zip-loc bag

An expendable friend

### What You Do

1. Trip your friend and then pour prussic acid down his throat.
2. Nod in understanding as he gasps curses at you.

3. Fill a cup with water and sodium thiosulfate in equal measure.
4. Make your friend drink the diluted sodium thiosulfate. He may be a bit reluctant seeing that you've already poisoned him.
5. Turn your attention to the ankle.
6. Pour water and sodium thiosulfate into the plastic bag in equal parts.
7. Seal the bag and shake it. The mixture should become very cold.
8. Put the bag on your friend's ankle.
9. Tell him not to thank you. His smiling face is thanks enough.

### **Why It Works**

*As an antidote:*

Prussic acid poisoning, aka cyanide poisoning –got your attention didn't we? – is rapid and lethal. Sodium thiosulfate, along with sodium nitrite (optional), is the standard antidote for cyanide poisoning.

Sodium thiosulfate helps the body convert cyanide in the less toxic thiocyanate. It reacts with cyanide to produce sulfite and thiocyanate ions:

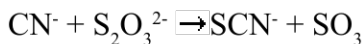

MacGyver used sodium thiosulfate as an oral antidote, which might do in an emergency, although sodium thiosulfate is poorly absorbed by the intestines. In practice, sodium thiosulfate is injected directly into blood stream in small doses over an extended period of time.

*As a cold pack:*

Sodium thiosulfate, when dissolved in water, lowers the temperature of the water. Chemists call this an endothermic reaction. Basically, the sodium thiosulfate requires energy to break its chemical bonds to dissolve. It takes this energy from the water. When you remove energy from something, it becomes colder.

A cold pack you buy at the store relies on the exact same endothermic reaction, except instead of using sodium thiosulfate, it uses ammonium nitrate, which requires even more energy to dissolve and thus chills the water even further.

## **Top Five Ways to Pick a Lock**

1. Your MacGyver knife (TOO MANY TO COUNT)
2. The wire surrounding a champagne cork  
(136 GUNZ 'N BOYS)
3. A hairpin (101 LOST AMADEUS)
4. The firing pin of a gun  
(140 LOST TREASURE OF ATLANTIS)
5. The metal casing of a overhead light  
(106 HUMANITY)

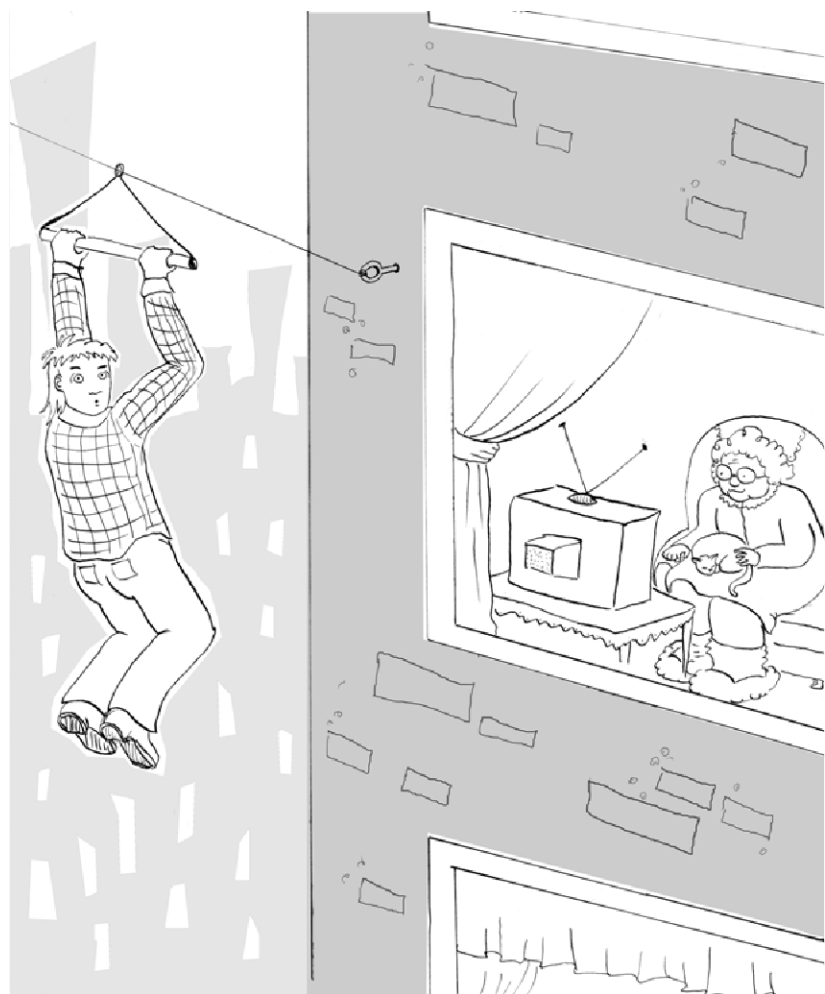

## **Breaking and Entering**

## How to Crack a Safe with a Telephone Handset

*As Seen in Episode: 106 – Humanity. MacGyver and Thornton are left to the mercies of a Romanian agent still loyal to his deposed leader Ceausescu after a mission to obtain his secret files is sabotaged.*

### What You Need

A safe with a combination lock

A telephone

### What You Do

1. Remove the handset from the telephone. The handset is the part of the telephone into which you speak.
2. Open up the handset. On some phones, mostly older models, the mouthpiece and earpiece screw off. For a newer phone, smash it open with your shoe heel.

3. Remove the microphone and speaker. The microphone will be in the mouthpiece and the speaker will be in the earpiece. See diagram.

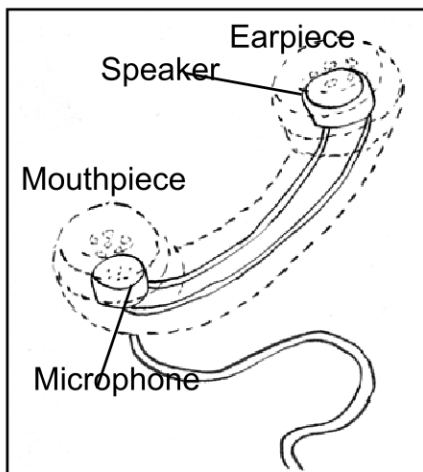

4. Rewire the speaker directly to the microphone. Fortunately, there are only two wires. Tie both wires to the microphone.
5. Hold the microphone up to the safe door, next to the combination dial.
6. Turn the dial three times to the right to reset the lock.

7. Slowly turn the dial to the right until you hear a click.
8. Slowly turn the dial to the left until you hear a second click.
9. Turn the dial back to right until you hear a third and final click.
10. Congratulations! You can now open the safe.

### **Why It Works**

Most safes have combination locks. Combinations locks have a dial which when turned to a specific sequence of numbers will open. Anyone who had a locker in high school will be familiar with the left, right, left turning sequence. The key to cracking a combination lock is to detect the slight click that occurs when the dial is turned to the correct number. In order to hear this click, MacGyver used the microphone and speaker from the telephone to amplify the clicking sound. Of course, a doctor's stethoscope would work just as well.

## How to Fool a Thumbprint Reader

*As Seen in Episode: 089 - Halloween Knights.*

*MacGyver's not sure whether it's a trick or a treat when his ruthless rival Murdoc asks for help to free his innocent sister, who's being held captive by a vengeful ex-employer.*

### What You Need

Chalk  
Candle wax  
A glass of water

### What You Do

1. Identify a person with the appropriate clearance to bypass the thumbprint reader.
2. Hand them a glass to hold while you tie your shoe.
3. Thank them. Remember, a hero is always polite.

4. Crush the chalk into a fine powder and lightly blow it on to the glass. The person's thumbprint should now be clearly identifiable.
5. Melt the candle wax onto you thumb.
6. Press the wax against the thumbprint. The chalk print will adhere to the warm wax and you will have acquired the thumbprint you need. Congratulations!

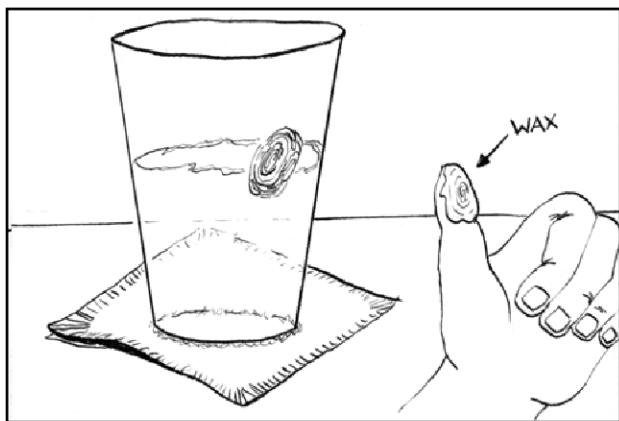

## Why It Works

As made evident on countless television detective shows, the oil from your finger leaves a residue on any surface you touch. The chalk particles stick to this oil creating an image of the grooves of your finger, a fingerprint. The chalk attaches to the wax when the wax is pressed against the print. The smooth surface of the wax holds the chalk fingerprint. The wax-chalk thumbprint effectively mimics the actual thumb and fools the thumbprint reader.

Don't have access to pool chalk and wax? Use your lungs. According to a recent German study, simply breathing on most fingerprint readers can defeat them. The moisture of your breath fogs the glass on the reader, making the fingerprint of the last person who used the reader appear on the glass. The reader sees the print and accepts it as valid.

## How to Hotwire a Phone to Listen to a Call in another Hotel Room

*As Seen in Episode: 075 - The Battle of Tommy Giordiano. When a kid is kidnapped by his estranged father, Mac tries to help the mother rescue the boy. But the father is the son of an aging organized crime kingpin whose control is being threatened by subordinates.*

### What You Need

Your MacGyver knife  
A telephone, not a cellphone  
A hotel

### What You Do

1. Sneak into the hotel room in which you want to eavesdrop.
2. Look at the phone jack. A number should be written on the jack.
3. Find the nearest supply closet. In a proper installation, a connection block will be mounted in a closet relatively close to the room.

## Connection Block Diagram

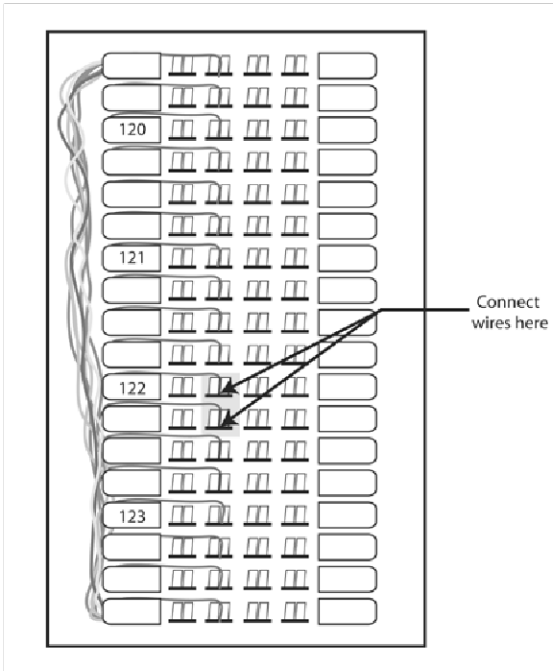

4. Once you've located the connection block, look for numbers written along the edge of the block. These numbers should correspond to either the hotel room numbers or the telephone jack numbers.

5. Go back to your room and disconnect the telephone from the wall jack of your room. Be sure to take the gray line cord that is attached to the wall.
6. Cut the line cord and strip back the plastic sheath to reveal the wires inside.

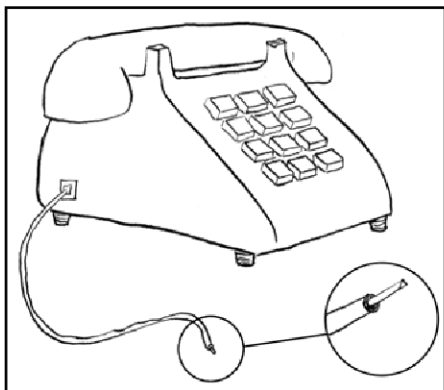

7. Connect the wires of the line cord to the section of the connection block next to the indicated room number.
8. Wait until your target receives a call. Your phone will ring as well. Give the target time to answer then listen in.

## Why It Works

If you think the Internet has security problems, you've never examined the telephone system. When you make a phone call, your voice is transmitted over a pair of copper wires to the telephone company and they retransmit it over their fancy-schmancy fiber-optic network until it reaches the other end where it finishes its journey over those two copper wires again. At any point while the signal is being carried over the copper wire, anyone can tap into the signal by exposing the wires and connecting their own telephone. In fact, these so-called tappers can even make phone calls using your phone connection.

Of course, tapping phones is a federal offense, so we'd advise not trying these techniques except on your own phone. Yes, MacGyver committed a criminal act. Thank God for those high-powered Phoenix Foundation lawyers, otherwise poor Mac might be sunning himself in low-security federal penitentiary.

## How to Fool a Motion Detector with a Lamp

*As Seen in Episode: 082 – Renegade. A mentally disturbed man steals a precious vial of deadly bacteria, and MacGyver is shocked when a confrontation with the thief reveals that he's a friend who once saved his life.*

### What You Need

A motion detector

A lamp (very bright and with a long cord)

### What You Do

1. Turn on the lamp.
2. Aim lamp directly at the motion detector.
3. Move forward while holding the lamp directly at the detector.
4. Place the lamp directly in front of the detector. You can now move freely without triggering the detector.



### Why It Works

Many motion detectors use infrared light to detect motion. Moving objects change the amount of infrared light striking the detector. By directing the lamp at the detector, you effectively flood the space with infrared light, masking the changes in infrared light that occur when you move.

## **Bypass a Keypad Lock with a Pencil**

*As Seen in Episode: 049 - Fire and Ice. A thief kills MacGyver's old friend, leaving a trail of stolen jewels that leads straight to a foreign consulate. Hey, this just happened to us last weekend.*

### **What You Need**

- A keypad lock
- A pencil
- A piece of paper

### **What You Do**

1. Crush the lead of the pencil into a fine powder.
2. Pour the lead dust onto the piece of paper.
3. Blow the finely crushed lead onto the keypad. Be sure that the lead is distributed evenly across the keypad.

- Note which keys have the highest concentration of pencil lead.

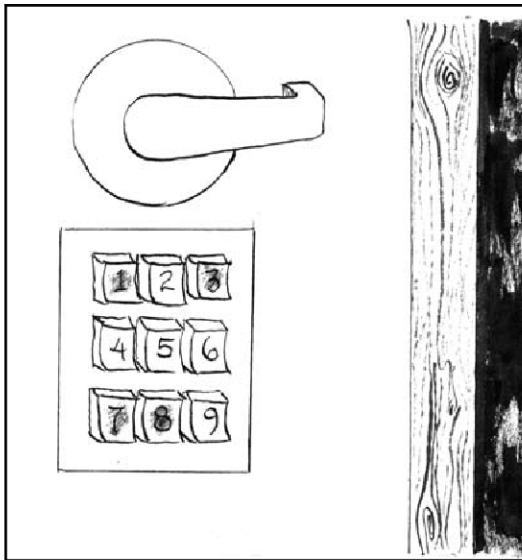

- Press the key with the highest concentration of pencil lead.
- Press the key with the NEXT highest concentration of pencil lead.
- Continue until the sequence is completed.

## **Why It Works**

When your finger touches a surface, it leaves an oily residue. Each succeeding touch will leave slightly less oil. And, of course, the more you touch the each key, the more oil you will leave on that particular key. So to clarify, the first key will have the most oil and therefore the most lead.

## How to Disarm a Laser Beam Alarm System

*As Seen in Episode: 001 – Pilot. MacGyver is tasked to rescue scientists trapped in an underground lab protected by a deadly security system.*

### What You Need

A laser beam alarm system

A cigar

Binoculars

### What You Do

1. Light up your cigar. Ahh, isn't that nicotine soothing.
2. Blow smoke in the direction where you believe the laser beam to be. The smoke particles will make the beam visible without triggering the alarm.
3. Remove the clear glass eyepiece from the binoculars. You may have to break the binoculars but be careful not to damage the eyepiece.



4. Use the eyepiece to redirect the laser back at its source. This will disable the laser.

### **Why It Works**

File This Under: Don't Try This On My Next Heist. Simply redirecting a laser back at its source is much more likely to trigger the alarm than to disable it. A

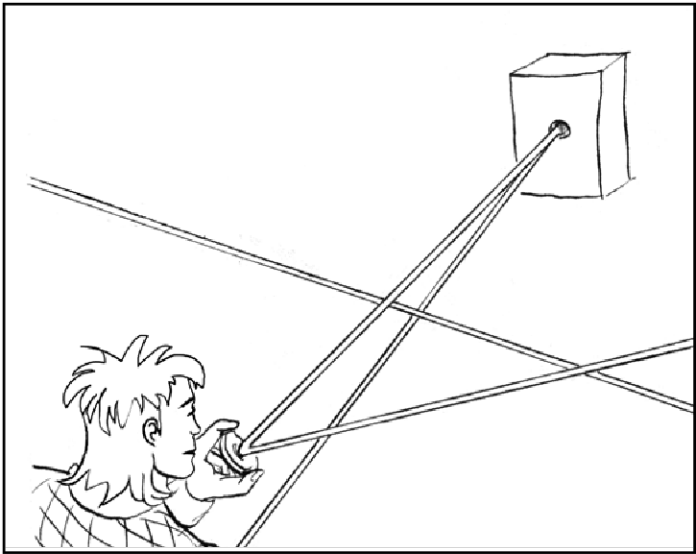

laser beam alarm is activated if the beam is interrupted. By inserting an eyepiece or mirror or anything else into the beam, you interrupt the beam, likely triggering the alarm. We say, sit back in your recliner, light up another cigar and figure out some other way to get those secret plans.

## How to Bypass a Motion Detector with Chemistry

*As Seen in Episode: 053 - Hell Week. A frustrated physics student at MacGyver's alma mater becomes a ticking time bomb when a school contest turns into a family war.*

### What You Need

Ammonia  
Acetic acid  
Two spray bottles

### What You Do

1. Pour the ammonia into one of the spray bottles.
2. Pour the acetic acid into the other spray bottle.
3. Cautiously approach the motion detector.

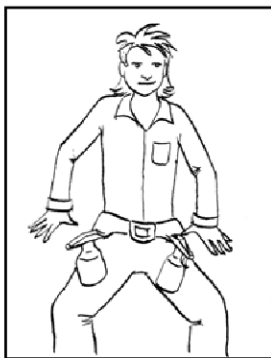

4. Spray both bottles. The chemicals will combine to form a warming smokescreen.
5. Run past the motion detector. Yelling, "Woo hoo! Woo hoo!" as you run by is optional, but not recommended.

### Why It Works

The reaction between the ammonia and the acetic acid excites the molecules of ammonia, creating a warming (but toxic) mist. Such a reaction is known as an exothermic reaction, one that generates heat. As we all know, many of today's ultramodern motion detectors operate by sensing changes in temperatures. The

heat created by the exothermic reaction increases the ambient temperature of the room. Once the temperature hits 98.6 degrees (the temperature of the human body), a person can pass through the room undetected. The smokescreen adds a nice visual touch for your television audience.

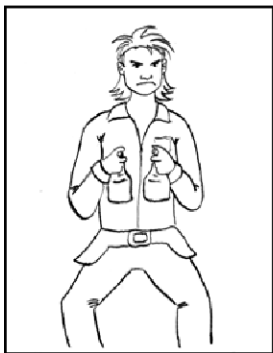

## How to Pick a Lock with a Pocket-knife

*As Seen in Episode: What episode wasn't it in?*

### What You Need

Your MacGyver knife  
A door lock

### What You Do

1. Insert knife into lock.
2. Say Shazam!
3. Turn the knob.
4. Open the door.

### Why It Works

It won't, unless...the door was already unlocked.

Most door locks are simple cylinder locks. This type of lock consists of a grooved cylinder and small metal pins which fall into the groove preventing the cylinder from turning. When you insert the key, the ridges of the key match up with the small metal pins and push them upward. With the pins raised, the cylinder is able to rotate and the door knob can turn. The door is unlocked.

If you actually want to pick a lock you will need two things: a tension wrench and a pick. Fortunately, both these items can be made from simple household items. The tension wrench can be an allen key, with the long part filed to be narrow. A bent bicycle spoke can be used as the pick.

Okay, so here is the real way to pick a lock.

1. Insert tension wrench into lock.
2. Turn the wrench to apply tension onto the cylinder of the lock. The cylinder is the section that moves when you turn the key. By applying tension to the cylinder, you create a ridge near the top of the lock for the locking pins to rest upon.

3. Scrape the inside of the top of the lock with the pick. The scraping action will push the locking pins upward.
4. Once all the pins have been pushed upward, the tension on the wrench will give and the knob will turn. The lock has been picked.

## How to Break into a Building the Cool Way

*As Seen in Episode: 136 - Gunz N' Boys. Mac tries to help a boy prepared to take the rap for another boy murdered by weapons dealers.*

### What You Need

A building with an air conditioner (preferably on the ground floor)

Your bare hands

### What You Do

1. Rip the air conditioner off the wall. Ta Da!
2. Crawl in through the hole in the wall.
3. Eat the terrorist's extra spicy chili for which you've been hankering. Boy that's hot, bet-cha wish you had some way to cool down.
4. Curse the jerk who ripped out the air conditioner.

## Why It Works

In this case, why it works doesn't really matter. However, we think this is a really cool trick because it reveals how the flaws in a security system can be so obvious that no one sees them.

In this case, the flaw is a air conditioning unit. The front door to the building may have a dead-bolt, but by simply walking around to the side of the building, a thief can enter via the air conditioner route.

Our favorite example of a security flaw: a couple years ago, in Washington, DC, a homeless thief went on a crime spree targeting office suites in high-end office buildings easily bypassing the most secure doors. He did so by hammering through the drywall next to the door creating an opening through which he could enter the office suite. Brilliant and homeless. Sorry ladies, his number is unlisted.



## **Top Five Diversions**

1. Remote Control Blimp (109 THE WALL)
2. Fireworks on a Church Bell  
(004 THE MAP/GAUNTLET)
3. Burning Rum (063 ENDANGERED)
4. Lantern Thrown at Crates  
(068 ON A WING AND A PRAYER)
5. Window Cleaner and a Light Bulb  
(128 OBSESSED)



## **Party Tricks and Diversions**

## Undress a Woman without Using Your Hands

*As Seen in Episode: 005 – Heist. In the Virgin Islands, MacGyver and a senator's daughter must recover \$60 million in stolen diamonds earmarked for a relief fund.*

### What You Need

A paperclip

A long piece of thread (more than four feet long)

A woman wearing a zip up dress

A crowd of innocent bystanders

### What You Do

1. Slightly bend one of the ends of the paper clip to make a hook.
2. Tie the piece of thread to the paperclip.
3. Sneak up to the woman while she is preoccupied, talking to another person.

4. Attach hook of paperclip to the zipper of the dress. The thread will now be dragging along the floor.
5. Sneak away to far side of room.

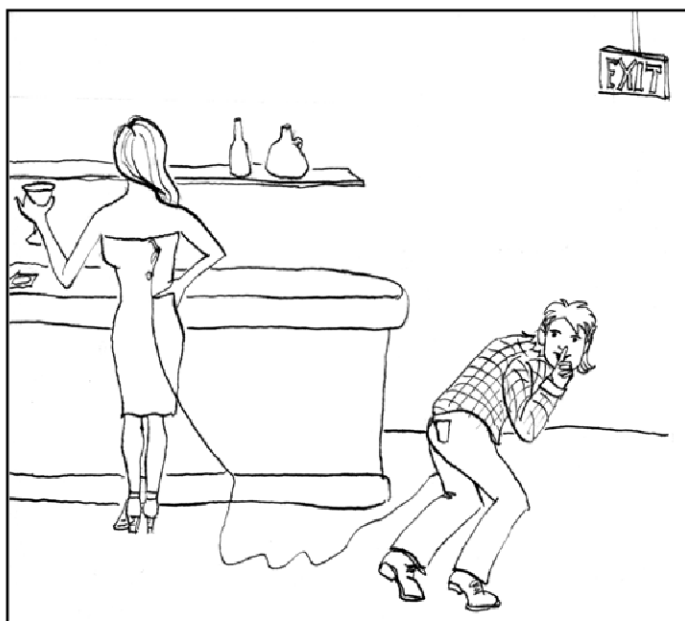

6. Wait until the woman makes her way across the room.

7. As she walks, one of the party guests will eventually step on the thread. The thread will tense and pull the zipper down. As the zipper lowers, the dress will slip off the woman.
8. Watch as partygoers ogle woman.
9. Send us some photos.

### **Why It Works**

The force created by the tension of the thread is in the opposite direction of the momentum of the woman's movement. This force exploits the weakest point of resistance: the zipper. After the zipper comes down, so does the dress. And what better diversion is there than a half-dressed woman? Ok, a naked woman, but you get the point.

## How to Make Buffed Dice

*As Seen in Episode: 005 – Heist. In the Virgin Islands, MacGyver and a senator’s daughter must recover \$60 million in stolen diamonds earmarked for a relief fund.*

### What You Need

Dice  
A shoe polisher  
Powdered soap

### What You Do

1. Pour a small amount of powdered soap onto the shoe polisher.
2. Turn on the shoe publisher.
3. Hold the dice against the shoe polisher for a few seconds. **BE CAREFUL:** Putting your hand against a shoe polisher is dangerous and can result in injury.
4. Make sure that the sides of the dice being polishing are on the opposite side of the number that you want to roll.

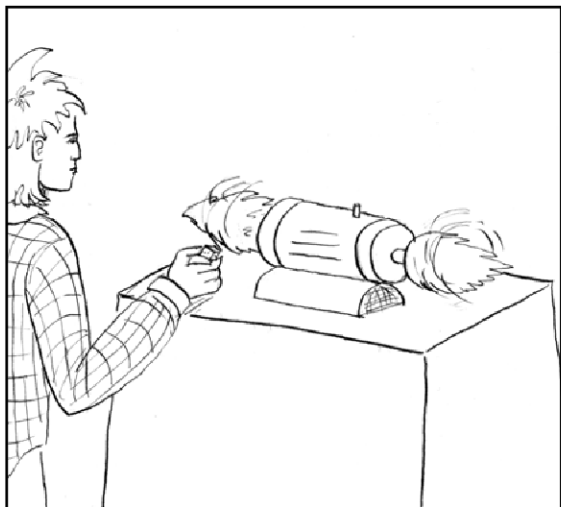

### Why It Works

Although this would probably only work at senior center gambling nights, it appears like Mac may have found a way to beat the odds. Dice are manufactured so each side weighs the same. If one side were heavier than another you would influence the odds of rolling a certain number. Mac uses a shoe polisher to increase his odds. The polisher smoothly removes a thin layer of plastic on one side of the die, causing that side to weigh less. Thus, on average the number on the lightest side should come up much more often when the die is cast.

## How to Make a Lie Detector with a Blood Pressure Cuff and an Alarm Clock

*As Seen in Episode: 019 - Slow Death. Mac and a trainload of passengers are taken hostage by a tribal chieftain seeking the men responsible for his son's death.*

### What You Need

A blood pressure cuff  
An alarm clock  
Copper wires  
Tape

### What You Do

1. Open up the alarm clock.
2. Create a looped circuit between the battery and the alarm using your two copper wires. This step will be easy or difficult depending on the complexity of the alarm clock's interior. In general, older alarm clocks will have simpler circuitry.

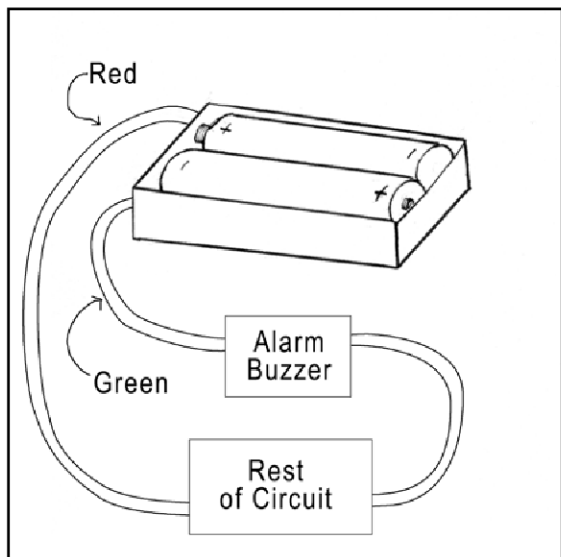

3. Tape the ends of both copper wires to the subject's arm. The wires should be about one centimeter apart.
4. Put blood pressure cuff around subject's arm.
5. Question the subject. Sample question: Did you or did you not leave the toilet seat down?

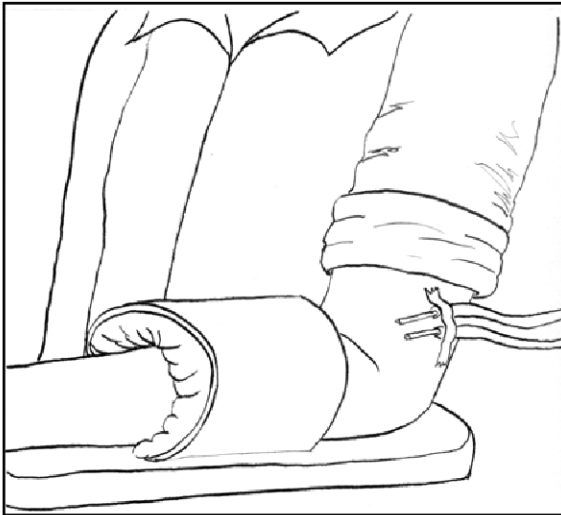

### Why It Works

A lie detector, otherwise known as a polygraph, works by monitoring changes in the body in reaction to the stimulus (i.e., questions) provided by the interviewer. Scientists know that when a person lies it causes a distinctive reaction in the body, which can be identified by looking at the following factors: heart rate, blood pressure, respiratory rate and electro-dermal activity (sweatiness).

MacGyver's lie detector tests only two of these factors: blood pressure and electro-dermal activ-

ity. Blood pressure is easy to test but doesn't give an accurate representation of whether or not the subject is telling the truth in part because blood pressure can change for many reasons. The second, and more interesting element, of Mac's lie detector is the alarm clock. When the person sweats, the electrolytes in his or her sweat allows electricity to readily pass between the two copper wires (copper is an excellent conductor of electricity) and complete an electrical circuit, which triggers the clock's alarm.

### **Would It Really Work?**

In theory, perhaps. Lie detectors are typically not considered reliable enough to be admitted as evidence in a court case, and that's when the test is administered by an expert. This homemade lie detector tests the same factors (blood pressure and electro-dermal activity) as a fancy lie detector but with even less accuracy. Of course, if you really want to know if your girlfriend slept with your brother, this may just do the trick.

## How to Make a Fake Blood Trail

*As Seen in Episode: 066 - Blood Brothers. Back in his home town, MacGyver finds past and present overlapping as he remembers a fatal shooting accident from his youth while trying to stop his old friend's son from using a gun to defend himself against drug-dealing hoodlums.*

### What You Need

Drain cleaner

Phenolphthalein solution

**WARNING:** Drainer cleaner is a toxic chemical and great care should be used in its handling.

### What You Do

1. Mix the drain cleaner and the phenolphthalein solution. They should combine to form a dark red, blood-like color.
2. Dribble the fake blood in little spots.

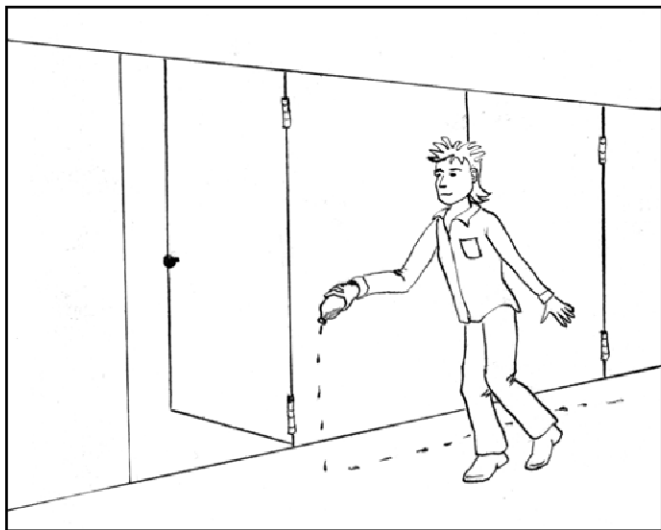

3. Be sure to make the trail end at a closet, bank safe, or industrial freezer.
4. Hide nearby and wait for thug to appear.
5. When the thug looks into the closet, bank safe, or industrial freezer, kick him in the back. This will send the thug sprawling into the closet, bank safe, or industrial freezer.

6. Shut the door behind him.
7. Order some pizza.

### **Why It Works**

Phenolphthalein is a chemical used to test acid/base levels of liquid chemical solutions. By placing a few drops into a very basic, or alkaline substance, it will turn bright pink. The more alkaline present in a solution means the more the phenolphthalein will react and change color.

Drain cleaner contains sodium hydroxide, also known as caustic lye, a highly alkaline substance. Because of the high alkaline level present in the drain cleaner, the phenolphthalein turns a very dark pink, or reddish color.

### **Would It Really Work?**

Only if the drain cleaner contains an extremely strong alkaline. Otherwise, the only person who the killer will think is bleeding is Bozo the Clown because the “blood” will be fluorescent pink.

## Make a Soda Machine Shoot Cans of Soda

*As Seen in Episode: 103 - Rush to Judgment. As a juror in a racially charged murder trial, MacGyver can't resist digging up more facts on his own, thereby courting the wrath of the judge.*

### What You Need

Half a cup of salt

Two-liter bottle of lukewarm water

A newspaper

An evil soda machine

### What You Do

1. Pour salt into water bottle.
2. Shake bottle, mixing the salt and water thoroughly.
3. Roll up the newspaper into a funnel.

4. Use the newspaper funnel to pour the salt-water solution into the coin slot of the evil soda machine.

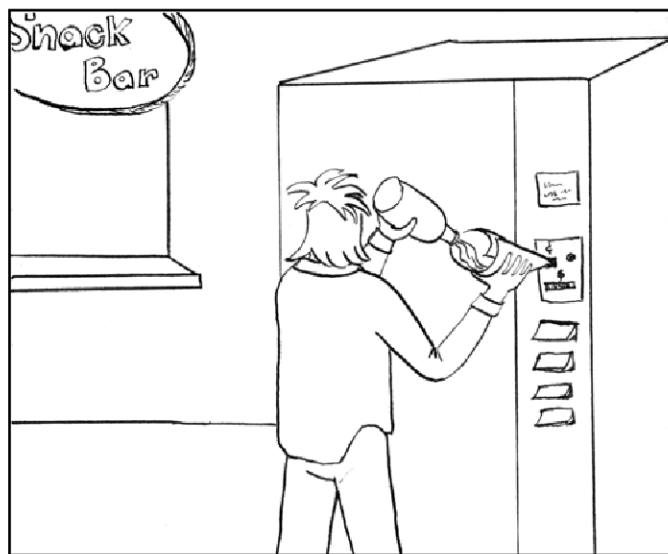

5. Stand back as the soda cans come rolling out.
6. Enjoy your free, if slightly shaken, sodas.

## Why It Works

Inside the soda machine is an electric switch that controls the release of soda cans. The combination of salt and water create a mild electric charge. When the salt and water is poured through the coin slot it washes over the electric switch controlling the release of the cans. The salt-water solution creates what chemists call a salt-bridge of which an electric current passes readily through, causing the machine to short-circuit itself. This in effect, trips the electric switch, and as a result the machine spits out soda cans.

Before getting too excited about a free sugar high, keep in mind that this trick only works on older soda machines. Nearly every soda machine in the United States has been replaced with newer models on which this trick will not work. But, oh, those Guatemalan soda machines are just waiting for your electrochemical shenanigans.

## How to Turn Out the Lights with Formula 409

*As Seen in Episode: 64 – Obsessed. Recurring nightmares about Murdoc make MacGyver sleepless and on edge as he provides security at the criminal trial of a deposed dictator.*

### What You Need

A light fixture with a standard light bulb  
Formula 409  
Gun-toting thugs

### What You Do

1. Wait until the thugs are underneath the lightbulb.
2. Brandish Formula 409 bottle in a threatening manner.
3. As the thugs are paralyzed with laughter at your ridiculous ploy, spray Formula 409 on the light bulb. Use liberally.

4. Watch as the imploding light bulb drives tiny shards of glass into the faces of the thugs.
5. Run past blinded thugs.

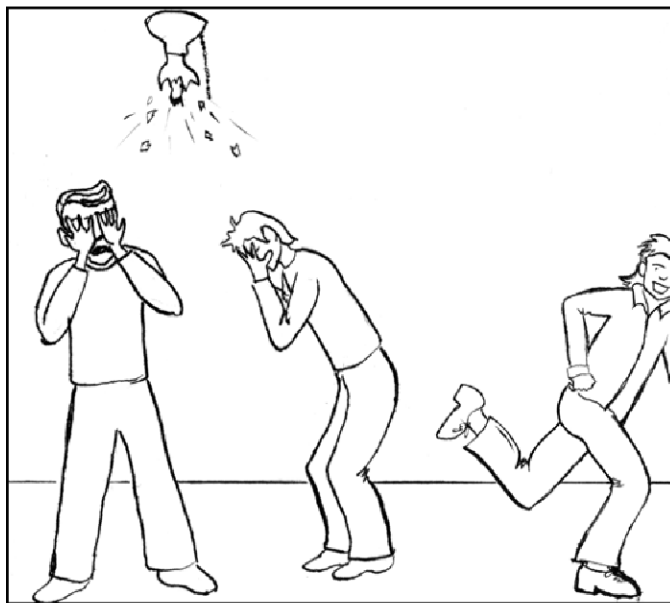

6. Rest.
7. Run some more.

8. Have a beer and laugh about the dumb thugs and their plastic surgery bill.

### **Why It Works**

Most lightbulbs are made of soda-lime glass. The Formula 409 window cleaner contains the chemical sodium hydroxide (NaOH) a corrosive chemical that reacts with the glass on the lightbulb. Because the glass in a light bulb is extremely thin, the NaOH eats through the glass very quickly. Then, because the inside of a light bulb is a vacuum (the complete absence of air) the outside air instantly rushes in to fill the vacuum, causing it to implode, the glass to shatter, and fall on the thugs.

## How to Create a Magnet with an Iron Bar and a Fire Hydrant

*As Seen in Episode: 011- Nightmares. MacGyver escapes from foreign agents after being injected with a hallucinogen that will kill him in six hours if he can't get the antidote.*

### What You Need

An iron bar

A hydrant

A compass

### What You Do

1. Locate true north on a compass.
2. Hold the iron bar so that one end points towards the North Pole and the other end points to the South Pole.
3. Strike the iron bar repeatedly on the hydrant.
4. Impress your friends by using the iron bar to pick up paperclips.

## Why It Works

First of all, this trick doesn't work if you use babies or small animals. They just cry if you smack them on a hydrant. You have to use iron. An iron bar consists of billions of individual atoms, each of which has magnetic properties. These atoms get together in groups called domains. These domains all have their own polarity, which means all the atoms in the domain point the same way. Now all these domains would love to line up with the magnetic field of the earth (i.e. point north) but they can't because they're stuck. By smacking the iron bar onto the hydrant you allow them to move around and align themselves with the earth's magnetic field. If enough of the domains align properly then the entire iron bar takes on the domains' alignment and becomes magnetic as well.

## How to Escape from a Boring Dinner Party

*As Seen in Episode: 108 – Twenty Questions. MacGyver tries to help a teenage friend with a drinking problem that's already led to her involvement in a string of burglaries.*

### What You Need

A boring dinner party

A desk lamp

A small figurine

A table

A dressing screen

### What You Do

1. Go to a boring dinner party.
2. Tell your host that you're feeling a bit self-conscious about your appearance and you want to stand behind the conveniently located dressing screen in the corner.

3. Drag a small table behind the screen.
4. Place the figurine on the table.
5. Place the desk lamp behind the figurine.
6. Turn on the light.
7. Adjust the lamp so the shadow of the figurine falls on the dressing screen.
8. Chuckle as the rest of the guest think that it's your shadow on the screen.
9. Sneak off with a cute waiter or waitress and hope that no one asks you a question.

### **Why It Works**

It's a pretty straightforward illusion. The closer an object is to a light source, the larger its shadow will appear, thus something tiny can appear very large when placed close enough to the light source. Guys, we know what you're thinking and all we can say is hot light bulbs leave scars. Be careful.

## **Top Five Ways to Take Out Thugs**

1. A fire hose (058 THE ODD TRIPLE, 062 ROCK THE CRADLE, 097 LOG JAM)
2. A fire hose threaded through a ladder (105 TOUGH BOYS)
3. A fire hose threaded through scaffolding (127 THE HOOD)
4. A fire hose attached to a car axle (077 RUNNERS)
5. Love, understanding and a fire hose

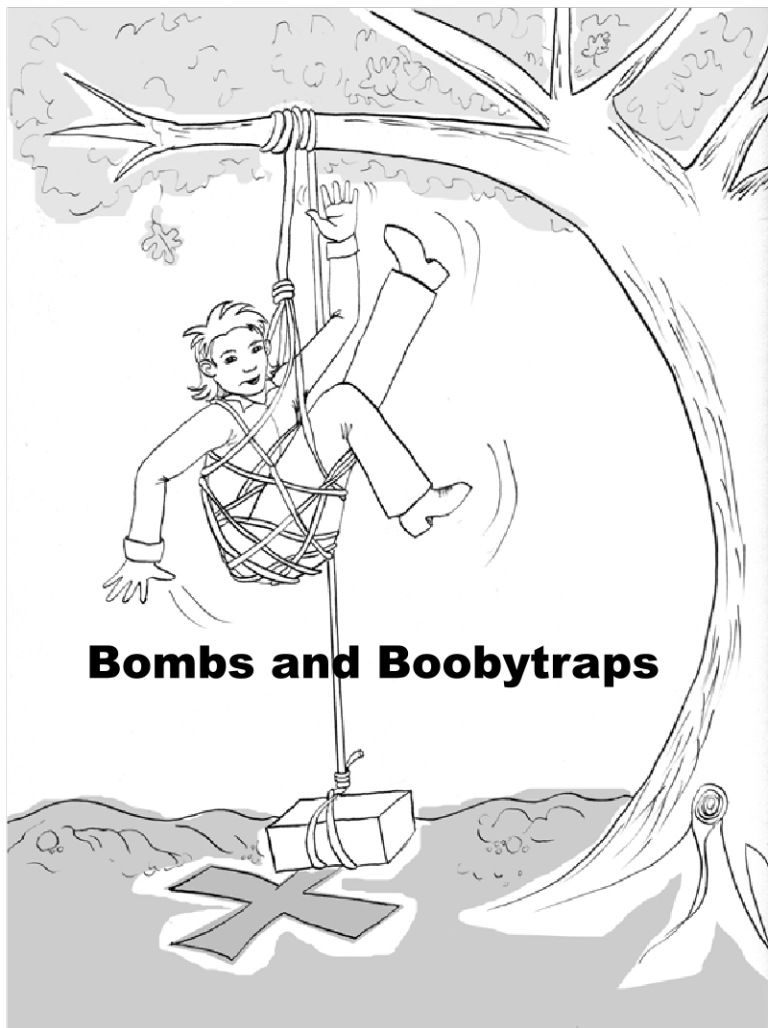

## **Bombs and Boobytraps**

## **Create a Timebomb with a Glass of Water, a Cold Capsule, and Sodium Metal**

*As Seen in Episode: 001 – Pilot. MacGyver is tasked to rescue scientists trapped in an underground lab protected by a deadly security system.*

### **What You Need**

A metal or plastic container of water.

A gelatin cold capsule (choose one that you can open and close by hand)

Some sodium metal.

**SAFETY NOTE 1: DO NOT** use a glass container. It will shatter when the capsule explodes. Little shards of glass will rocket through the air, causing injury to yourself or others.

**SAFETY NOTE 2: DO NOT** handle sodium metal with bare hands. Sodium metal will react to the moisture in your skin causing severe burns. **DO NOT** allow the sodium metal to come in contact with your skin.

## What You Do

1. Open the cold capsule by gently twisting the gel-based capsule apart.

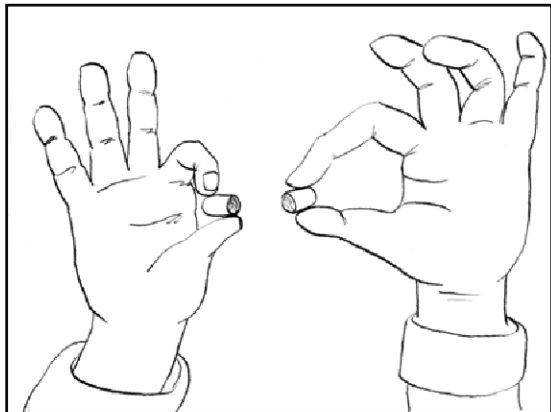

2. Empty out contents of the cold capsule.
3. Take small pieces of sodium metal (again, use tongs or wear gloves) and place them inside the cold capsule.
4. Close the capsule by screwing the narrower section into the larger section.

- Drop capsule into the container of water. BE CAREFUL. If the capsule was not completely sealed, then the capsule will explode as soon as the water hits the sodium metal.
- Hide behind some crates or a file cabinet. After a short time (5-10 minutes) the cold capsule will dissolve in the water. At this point the sodium metal will become exposed to the water.

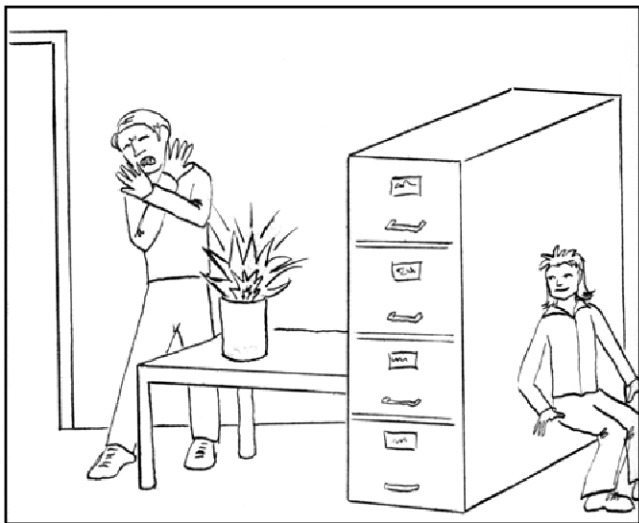

- BAM! When the sodium reacts to the water, it will explode, creating an intense hot orange flame.

## Why It Works

Sodium (Na) is a metal that forms a corrosive liquid when it comes in contact with water. Once the gelatin-based capsule dissolves, the sodium metal reacts rapidly with the water to form a colorless solution of sodium hydroxide (NaOH) and hydrogen gas (H<sub>2</sub>). The reaction is exothermic, meaning that heat is released during the reaction. In fact, the sodium metal may well become so hot that it catches fire and burns with a characteristic orange color. If only bad guys appreciated reaction chemistry like we do.

## How to Make Pinecone Landmines

*As Seen in Episode: 010 - Target: MacGyver. While visiting his estranged grandfather in Colorado, MacGyver is tracked and hunted down by a contract killer.*

### What You Need

Pinecones

Pine pitch (sticky resin contained inside the pinecones)

A lighter

A sack

**WARNING:** Remember, when working with explosive materials, even ones like pine pitch, one should be extremely careful.

### What You Do

1. Fill the sack with pinecones.
2. Spread the pine pitch on the top of the sack.

3. Bury the sack but leave the top of the sack exposed.



4. Wait until the thugs drive by in their jeep.
5. Light a pinecone and toss it in front of the jeep. In surprise, the thugs will stop the jeep. Luckily, this will happen directly over your landmine/bag of pine pitch.
6. Toss another flaming pinecone under the jeep. It will ignite the pine pitch and cause the bag of pinecones to explode.



## Why It Works

As anyone who has spent any time getting a PhD in forestry knows, pine pitch can be awfully darn flammable. In fact, pine trees have been known to explode during forest fires. The trees' pine pitch combusts when the forest fire causes the ambient temperature to reach a certain degree. Scientists aren't certain but they think this is the way some trees reproduce. Kinky.

**Would It Really Work?**

Sure, with enough pinecones and pine pitch from the right trees, you may get a small explosion. However, this would not be enough to blow up a jeep. A Pinto perhaps, but not a jeep.

## Fend Off Thugs with a Firehose

*As Seen in Episode: 097 - Log Jam. MacGyver tries to help an environmentally active friend find out what happened to a company whistle-blower about to expose the illegal practices of a large logging firm.*

### What You Need

A sawmill with a readily accessible firehose  
A thug

### What You Do

1. Aim firehose at thug.
2. Turn on firehose.
3. Grit teeth.
4. Hope thugs are allergic to water. *Author's Note:* You're playing the odds here. While approximately thirty people in the world are allergic to water (it's true!), we're not sure how many of them are thugs.

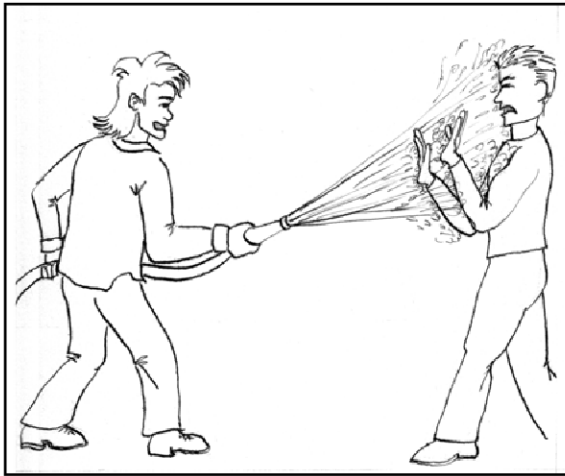

5. Drop hose and run.

### **Why It Works**

A firehose can expel water at up to 75 PSI (pounds per square inch)—enough force to knock over a man. That’s pretty powerful, but it pales in comparison to Ivan Drago, Rocky’s opponent in *Rocky IV*. A punch from the ‘Russian Concussion’ was registered at 1850 PSI. A more typical (non movie) heavy weight punch is a still respectable 180 PSI. No information on the PSI of the body blows that Stallone undoubtedly gave his agent for greenlighting Rocky V.

## How to Make Your Kitchen into a Deathtrap

*As Seen in Episode: 010 - Target: Macgyver. While visiting his estranged grandfather in Colorado, MacGyver is tracked and hunted down by a contract killer.*

### What You Need

A toaster oven  
Some pans  
Cooking oil  
A bag of ice  
A group of thugs

### What You Do

1. Stack the pans on the bag of ice as shown in the picture.
2. Place a toaster oven behind the stack. Turn it on. Be sure to leave the oven door open.
3. Pour cooking oil all over the floor.

4. Sneak out the back door.
5. Wait. Once the ice begins to melt, the pans will crash to the ground. The thugs in the adjacent room will rush in to investigate. The fools! They will slip on the cooking oil and take a nasty fall.

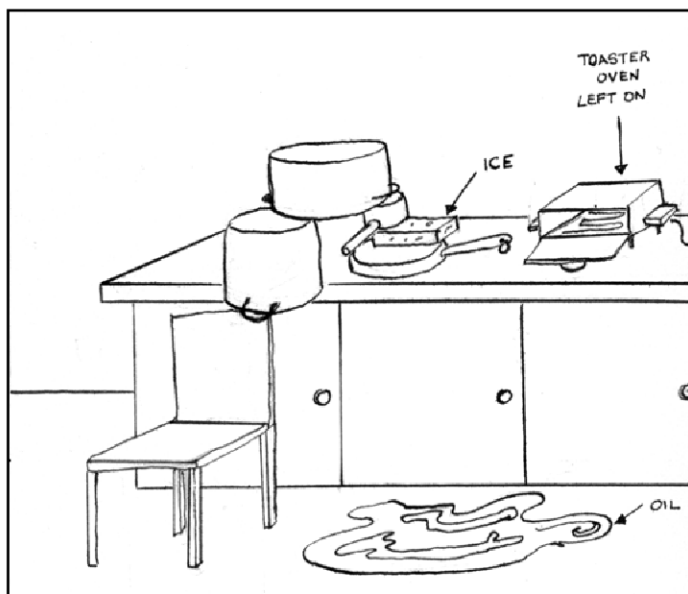

## **Why It Works**

Well, it's a pretty obvious, if unlikely, scenario. The heat from the toaster oven melts the ice. The pans hitting floor cause the thugs to wonder, "what is going on in there?" and come investigate. The thugs slip on the oil and fall on the floor, knocking themselves out.

What? Not enough death for you. Fine. Maybe they fell and couldn't get up? Did you think of that? You can't expect every thug to be a young, virile guy, can you? There must have been some crippled senior citizens on Murdoc's payroll. Okay, maybe deathtrap is too strong a word. How about oily, bruised butt trap?

## How to Disarm a Missile with a Paperclip

*As Seen in Episode: 001 – Pilot. MacGyver is tasked to rescue scientists trapped in an underground lab protected by a deadly security system.*

### What You Need

A missile, preferably with a nuclear warhead  
A paperclip

### What You Do

1. Open the missile's access panel. Usually, it is clearly labeled.
2. Straighten the paperclip into a long thin wire.
3. Jam the paperclip deep into the electronic innards of the missile.
4. Wriggle paperclip around.
5. Breathe a sigh of relief as the green LED indicating ACTIVATED changes to the red LED indicating DISACTIVATED.

- Use the same paperclip to enter the lottery, because clearly it has magical powers.

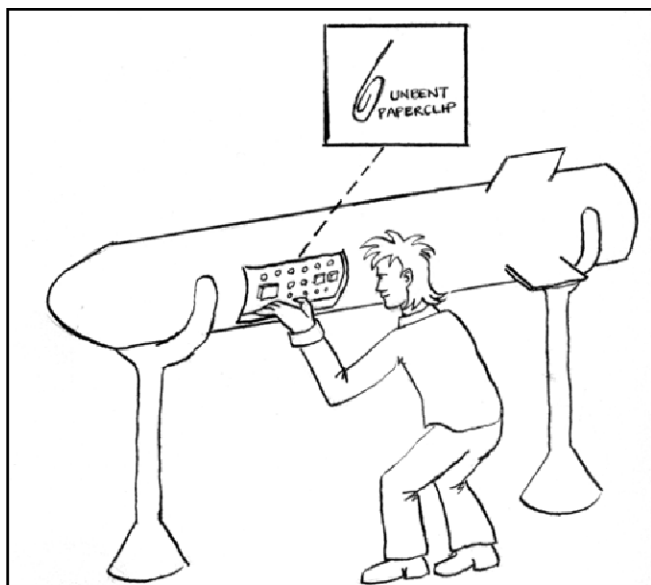

### Why It Works

As we mentioned, Mac's paperclip has magical powers. Or, MAYBE the missile Mac disarmed was the Soviet-engineered X-17 Missile, which can be deactivated simply by interrupting the electromagnetic field surrounding the payload core with a three inch, thin piece of metal. Yeah, sure.

# Appendix: The Complete List of MacGyver's Cool Tricks (a.k.a. Macgyverisms)

**Bold=covered in this book**

*Italic=very similar to something covered in this book*

## SEASON 1

### 001 PILOT

**Used a paperclip to disarm a missile**

Used a pack of matches and a rope to trigger a rifle  
Smashed the barrel of a flare gun to use as a rocket thruster to propel himself away from a cliff wall

**Disarmed a laser beam alarm with a cigarette and binoculars**

**Lifted a collapsed beam with a fire hose**

Tested a door with a stick to see if a fire raged behind it

**Stopped an acid leak with a chocolate bar**

Used a shirt to filter gases

**Made a time bomb with a glass of water, a cold capsule and sodium metal**

Flipped lights in Morse code

### 002 GOLDEN TRIANGLE

Stole a briefcase from thieves with an industrial magnet

Created a delayed fuse with a raft, a flare, and the air pump from a self-inflating lifejacket

Created a eye-stinging smokescreen trap with bamboo, alcohol, fire ash, and car exhaust

Attached a winch to a helicopter to keep it from flying away

### 003 THIEF OF BUDAPEST

#### **Faked a flat tire with a light bulb**

Made an explosive from salt, sugar, and weed killer

Created a magnifying glass with a looped piece of hair and white wine

Interfered with a traffic signal by inserting pieces of a credit card into the timing mechanism

Disrupted police communication by taping a radio to a police walkie-talkie and attaching them both to a bunch of balloons.

### 004 THE GAUNTLET

Used his knife to push a key out of a lock on other side of door onto a map

Rolled a map into a pea shooter

Fixed a hole in a hot air balloon with a map and duct tape

Bypassed barbed wire with a camera bag strap

Created a time bomb using a camera timer and plastic explosive

Created a diversion by taping fireworks to a church bell

Stopped a car by hooking a cable to the axle

#### **Made a car drive itself with a belt**

### 005 HEIST

#### **Undressed a women using a string and a paperclip**

#### **Created buffed dice with powdered soap and a shoe shine machine**

Tied a door shut with an electrical cord

Send a bar cart flying at thugs by breaking the seals on its CO<sub>2</sub> tanks

Hid a magnet from a phone receiver in a shoe to manipulate a roulette wheel

## Appendix

---

### **Picked a lock with his knife**

Created a automatic timer by wiring a fuse box to the hands of a clock

Bypassed a security camera with a mirror and coat hanger  
*Bypassed a laser alarm with ashes and a fiber-optic cable*

Replicated musical tones with wine and wineglasses

Parachuted out of a plane in a car

### 006 TRUMBO'S WORLD

Provided hot water by moving a shower pipe onto a fire

Lost pursuers by soaking a rope in kerosene and lighting it after rappelling down a cliff with it

### **Created an arc welder with jumper cables and two quarters**

Devised a torque-based pulley with an overhead beam, a rope, and a post

Created a flamethrower with a hose, a pump, a tank of gasoline, and a metal pipe

Made nitromannite explosive with nitrate from fertilizer, cellulose from plant bark, and nitric acid (note: sounds more like nitrocellulose)

Created a ant-repellent suit by melting a rubber hose onto mosquito netting

### 007 LAST STAND

Created a blowtorch using a magnesium bike frame, rust and a flare

Made a bomb out of cotton, newspaper, starter fluid (ether) and fertilizer (soaked it with olive oil)

### **Escaped from a meat locker with cardboard and a light bulb**

### 008 HELLFIRE

Bridged a fuse with a gum wrapper

Build a cradle for unstable dynamite with old wagon springs, a board, and some sand

Replaced broken linkage spring on a truck with the spring from a ballpoint pen

Made a track for a broken-down jeep (tires missing) with pipes

### 009 PRODIGAL

Hot-wired car with a paperclip

*Picked car trunk lock with knife*

Created a diversion with a saw, lumber, sawdust, and a vacuum

*Made a smokescreen with soda, Fizz Whizz and dry ice*

#### **Picked lock with knife**

Created a tripwire with a tube and some rope

Created a harpoon launcher and zip line using a telescope, camphor balls, cleaning fluid, cloth, a rod, electrical wire and a pulley

### 010 TARGET MACGYVER

#### **Picked a lock with knife**

#### **Booby-trapped a kitchen**

*Used a hose to trip thugs*

Created a decoy with reeds and log bark

Made a blowgun with hollow reeds and a poison plant

Made a decoy using a stuffed jacket

#### **Made pinecone landmines**

Mixed iron sulfide with clay to create antibiotic

Created a booby-trap with grain dust, a funnel, and drapes controlled from a distance with a fishing line

## Appendix

---

Distracted thugs with exploding pine nuts  
Created a booby-trap with a sawed-through support beam

### 011 NIGHTMARES

Made a fishing lure with a gum wrapper

Made a slingshot booby-trap with a metal cot and  
bedsprings

Flooded a circuit breaker with a belt, water, and an  
electrical outlet. (Used the belt as a tube to flood the outlet  
in his cell, the electrical conduit carried the water to the  
circuit breaker which short-circuited)

Booby-trapped a door with a car battery, a television tube,  
and jumper cables, a radio and two chairs

Surprised a thug by creating a leak in a tire, then when the  
thug bend down to kick in out, MacGyver kicked the car  
door into the thug's face (MacGyver had been hiding in the  
back seat)

Made a booby-trap with a rope, water jugs, boards, barrel,  
and a smoke alarm

**Made magnet by hitting iron bar on a fire hydrant**

### 012 DEATHLOCK

Jammed TV signals with a metal bowl and juicer

Made a motor with batteries, wires, a mixer, and some  
rubber bands

Made a decoy with a suit of armor, a kitchen cart and the  
homemade motor

*Created a smokescreen with vinegar and baking soda*

Put duct pipe around so he could hear the thugs approach

Used a mirror as a periscope

Shot water from a pressurized tank to knock over thug

### 013 FLAME'S END

Used a pistol as a wrench

### 014 COUNTDOWN

Made a rappelling line from a cargo net

Defused a bomb with a neon tube, a cork, milk, oven cleaner and a pastry tube

### 015 THE ENEMY WITHIN

**Repaired a bust brakeline when the car was moving**

Made nylon from adipic acid, hexmethylen diamene, iron, and a magnetic current

Made a defibrillator with candle holders, microphone cords and rubber from a carpet

### 016 EVERY TIME SHE SMILES

Escaped from a locked room at the airport using a coat rack, a wire hanger, a chair, and a baggage carousel

Made gas from rat poison, soap flakes, and tile cleaner (ammonia)

Made explosive with lard, a sheet of newspaper, crystallized oven cleaner, and natural gas

Made an oil slick by combining diesel exhaust (hydrocarbons) and water

### 017 TO BE A MAN

Created a hang-glider with satellite parts and a plastic shield

Used a butane tank as torpedo

*Used a fire extinguisher to expand water in a crack in a rock to start an avalanche*

## Appendix

---

### 018 UGLY DUCKLING

Made noise attack with an oscillator and a speaker

**Made an arc welder with jumper cables and two quarters**

Cooled Hot bars with old spray can (hydrocarbons)

**Made a cactus-powered radio**

Triangulated a location using two radios, a car antenna, watch, some wire, and the Sun.

Fired a gun with a car headlight, a mirror, and a binocular lens and the Sun

### 019 SLOW DEATH

*Distracted a thug with a faceful of salt and seltzer*

**Made a lie detector from blood pressure pump and an alarm clock**

### 020 THE ESCAPE

Created a miniature paper-machete hot air balloon with a soccer ball, olive oil, newspaper, and cotton balls

Emulated the sound of a helicopter with a spatula attached to a ceiling fan

Made an explosive with PCP & "volatile liquid" on clothes

Made a timer for explosive from a metal washtub, live wire, and ice

Created a fuse with powder from a grenade emptied onto cement

### 021 A PRISONER OF CONSCIENCE

**Caused a car to backfire with a potato**

Jammed a pursuing boat propeller with a rope, a life jacket and empty plastic gas containers

*Made a lockpick set with the filaments of a light bulb*  
Booby-trapped a bucket with caulk and hardening agent  
(ammonia?)

### 022 THE ASSASSIN

Escaped a dreaded parking lot by putting a board over the  
wheel gougers at the exit  
Tripped a thug with a garden hose

## SEASON 2

### 023 THE HUMAN FACTOR

Made a telescope with a newspaper, magnifying glass and  
a watch crystal  
*Simulated a handprint with plaster dust*  
*Redirected laser beam with mirror, mop bucket and a chair*  
Used pants to hang on pipe over boiling water  
Dispatched heat-seeking robots with magnets, matches,  
and paper  
Destroyed computer with electricity (shocking!)

### 024 THE ERASER

Short-circuited a keypad combination lock  
Rewired a car phone to lock car doors when a call was  
received  
Made a torpedo with a metal tube, a can, some rags and  
some gas  
Faked a death with some mirrors, red dye and rubber  
cement  
Emulated a police siren with foil and a comb

## Appendix

---

### 025 TWICE STUNG

Broke down a door with a fire hose and an elevator  
Made a blinding booby-trap with a battery, a floodlight, matchbooks, and a knife

### 026 THE WISH CHILD

Burst open a crate with a M-80 firecracker lit with the Sun and a watch crystal  
Made a grappling hook from a rope and an umbrella  
Blew up door lock with gunpowder and a bandana  
*Created a smoke screen with a fire extinguisher*

### 027 FINAL APPROACH

Made a tent out of a parachute  
Made a stethoscope from a radio headset and plastic tubing  
Made a theodolite (a surveying tool) from a branch and earrings  
Made a ski for an airplane from a hollowed log

### 028 JACK OF LIES

Unscrewed hot light bulb with cardboard tube  
Sling-shot an oxygen cylinder at pursuing thugs  
Plugged fuel leak with a stick  
**Recharged a battery with wine**  
Made a snare trap with a rope and the propeller of an airplane

### 029 THE ROAD NOT TAKEN

Made an alarm system with strings from inside a baseball and a bucket of stones  
Made a fuse with animal fat, baseball string and kerosene

Made a slingshot with tree branches and vines  
Burned through twine with rosary bead and the sun  
Used wire from broom as a saw  
Made a rocket with bamboo, fertilizer, a can and a rag

### 030 EAGLES

Splinted an eagle's wing with a broken arrow and cloth strips  
Fed bird used a pen  
Blew up a shed with a propane stove, ball bearings and a grindstone  
Made a slingshot with a bicycle inner tube attached to bicycle handlebars

### 031 SILENT WORLD

Made a water clock with two plastic trash bags, some branches, and string  
Booby-trapped front door with a rope snare

### 032 THREE FOR THE ROAD

**Used a ball point pen sheath to fix a fuel line**  
Made a mortar with a muffler, seat stuffing, gas, and a knob from the steering wheel  
Created a diversion with a car horn, wires, a car battery, a door and a horseshoe  
Made a flower bouquet from a newspaper

### 033 PHOENIX UNDER SIEGE

Made an electromagnet with a battery, copper wire, and a faucet pipe  
Zapped an electric lock with static electricity  
Disarmed a bomb with a hockey ticket

## Appendix

---

### 034 FAMILY MATTER

Pulled down a wall with rope, a metal bar, and an engine  
Made an explosive with an gas can and an oil soaked rag  
Made a bomb with bamboo, swamp gas, and mud

### 035 SOFT TOUCH

Made a blowtorch to burst a lock with magnesium from  
wheelchair casters, rags, and an iron pipe  
Lassoed a thug with speaker wire

### 036 BIRTH DAY

Knocked out a thug with the boom mast of a sail boat after  
hooking it with a fishing pole  
Made a helium balloon by soaking a cloth bag and filling it  
with helium  
Used fishing line to knock a thug off a motorcycle

### 037 PIRATES

Shot polystyrene balls with vacuum cleaner  
Made a hydraulic pump with a bilge pump, a boat bumper,  
and an angle brace  
Burst a boat hatch with a canister of compressed gas  
Disarmed an anti-personnel landmine tripwire with a string  
Disarmed a pressure landmine with a twig

### 038 OUT IN THE COLD

Escaped after being buried by an avalanche by drilling a  
hole through the snow with his ski pole, then blew a mini-  
parachute he made from a red handkerchief and a zipper  
through the inside of his pole to signal rescuers  
Read microfilm using water as magnifying lens on broken  
microscope

Electrified a fence with electricity

039 DALTON, JACK OF SPIES

Fired a stage cannon full of baby powder at thugs

*Escaped from the back of a garbage truck with a long piece of metal*

040 PARTNERS

*Made a car drive itself with a shoestring, a wrench, and a paperclip*

Blew up a door with shavings from an aluminum oil can and rust from an exhaust pipe, pantyhose soaked in oil (for fuse), and a battery

041 BUSHMASTER

Made a rifle fire itself by hanging it from a branch with a shoelace, tying the shoelace through the trigger and then around a rock. Then put paper next to the string and lit the paper so the paper would burn the string and let gravity work its magic

*Used Freon to shatter a lock*

Clogged a radiator leak with egg whites. Boiling water in radiator cooks the eggs. The cooked egg fills tiny holes.

042 FRIENDS

None

043 DOA MACGYVER

*Emulated a gunshot by slapping a board on concrete*

**Created a smokescreen with muriatic acid and ammonia**

## Appendix

---

### 044 FOR LOVE OR MONEY

*Made fake blood with red wine and red frosting*

Made a smoke bomb booby-trap from a rubber glove, carbon, oxygen, duct tape and a serving tray

Made an explosive from crushed nitroglycerine tablets, alcohol, napkins, and duct tape

Booby-trapped car door by connecting it via a baling wire to the ignition coil (20,000 volts)

### **SEASON 3**

### 045, 046 LOST LOVE

*Used powder cleanser to locate laser beam alarm system*

*Used hairpin to pick lock on handcuffs*

### 047 BACK FROM THE DEAD

Slide down a wire with a fire hose

### 048 GHOST SHIP

Made oars with a forked branch and a tent bag

Extracted water from a tree root with a metal tube

Made a booby-trap with fishing line and a fishing rod

### 049 FIRE AND ICE

Made a rappelling line with a rake head screwed onto a garden hose

**Bypassed a keypad lock with a pencil**

### 050 GX-1

Insulated a shirt with pine needles

Made boots from duct tape and plastic mat

Made full-size hot air balloon from a shed, a tent, a metal table frame, a compressor from a refrigerator and gas cylinders

### 051 JACK IN THE BOX

Made acetylene from carbide and water

### 052 THE WIDOWMAKER

*Made an arc welder from a car antenna, jumper cables, some wire and a car battery*

Climbed a telephone pole using a belt and a rope

Made a telegraph with a bracelet and a telephone cable

### 053 HELL WEEK

**Made a smokescreen with acetic acid and ammonia**

### 054 BLOW OUT

**Made homemade tear gas using a hot water bottle, baking soda, vinegar, and spices**

Tracked a thug's car by hanging a can of dripping yellow paint from the chassis

### 055 KILL ZONE

Sealed a silicon leak with a Bunsen burner and Freon

### 056 EARLY RETIREMENT

Made a smokescreen with a steam hose

### 057 THIN ICE

Replaced a solenoid spring with a flashlight spring

## Appendix

---

### 058 THE ODD TRIPLE

#### **Repelled thugs with a fire hose**

#### **Loosened rope tied around his hands with wine**

Broke through a wall with nitrogen canisters and a wheeled wine cask

### 059 THE NEGOTIATOR

Used a fire extinguisher to spray the windshield of a pursuing car

Made a booby-trap with jumper cables and a puddle of anti-freeze

### 060 THE SPOILERS

*Made a smokescreen with benzene and chlorine*

### 061 MASK OF THE WOLF

Created an explosive to open a tomb door with finely ground copper and zinc lit by a hemp belt soaked in oil

### 062 ROCK THE CRADLE

Fixed a plane's hydraulic landing gear while in midair with a canister of compressed air

Built a baby rocking crib with hockey sticks, rope, netting, and pillows

#### **Used fire hose on thugs**

### 063 THE ENDANGERED

#### **Removed distributor cap from thug's car**

Made a booby-trap with a forked branch, fishing line, and a tranquilizer dart

Signaled a helicopter with logs coated with limonite

Created a diversion with a coat, string, matches, and a branch

Fired a tranquilizer dart with a flashlight barrel and elastic cord from a coat

### 064 MURDERER'S SKY

Created sonar to find a secret passage with stereo speakers and a power cable

#### **Knocked out lights with window cleaner**

Made paper-machete walls to hide behind with paper, duct tape and mud

## SEASON 4

### 065 THE SECRET OF THE PARKER HOUSE

Recreated a face from a skull with pencil erasers and clay

Discovered a secret door with a lit candle to detect a draft

Torpedoed a wall with a pipe and a pressure steamer

### 066 BLOOD BROTHERS

Made a cart from a bicycle

#### **Made fake blood with drain cleaner and phenolphthalein solution**

### 067 THE OUTSIDERS

Used barrels to support a tunnel

### 068 ON A WING AND A PRAYER

Created a diversion by throwing a lantern at some crates

Patched a hole in a plane with lifejacket material

Sling-shot a plane with a rope so it could take-off on a short runway

## Appendix

---

### 069 COLLISION COURSE

Made a new gasket for a car

Tested for chlorine in water with silver nitrate

### 070 THE SURVIVORS

Slid between rock walls with a climber's pick and ropes

Made a decoy by stuffing a coat

### 071 DEADLY DREAMS

Used motor oil to see through a frosted window

Soaked matches with water to keep them from exploding

### 072 MA DALTON

Used a lug wrench to disconnect himself from a car

### 073 CLEO ROCKS

Tested sulfur with a spoon and a torch

Stunned Murdoc with an electric cord

### 074 FRATERNITY OF THIEVES

**Used sodium thiosulfate and water as an antidote to prussic acid poisoning**

Rewired helipad signal lights

### 075 THE BATTLE OF TOMMY GIORDANO

**Hot-wired phone for listening to calls in next room**

**Stopped a car from starting by putting a sock over the tailpipe**

Used telephone wire to bolt door shut

**Created a smokescreen with alcohol, ammonia, and hydrochloric acid**

### 076 THE CHALLENGE

Tested ink print with alcohol

### 077 RUNNERS

Tied a car to a garbage dumpster with a hose

### 078 GOLD RUSH

Created amplifier for an old Dictaphone with a pin and a rolled up map

Blew away snow with vodka, string, and oxygen

Disarmed a landmine with a backpack frame

Used a cargo plane door as a sled

### 079 THE INVISIBLE KILLER

Used a slingshot to attack thugs with leaves and dirt

Used a telescope to shoot vinegar and pepper

Created a snare trap with a rope and pulley

### 080 BRAINWASHED

None

### 081 EASY TARGET

Replaced a grenade pin with a lift ticket wire

Blew open a door with explosive from the grenade

Rewired walkie-talkies for distraction

Short-circuited an electro-magnet

### 082 RENEGADE

**Bypassed motion detector with a light bulb**

### 083 UNFINISHED BUSINESS

None

## Appendix

---

### SEASON 5

084, 085 LEGEND OF THE HOLY ROSE I & II

Built a two seat airplane

Escaped from deadly pendulum using his shoes

Used a flag to climb the castle wall

Used bellows as a pea shooter

086 THE BLACK CORSAGE

**Cut ropes binding his hands on fish teeth**

Distracted thugs with a Merry Go Round

**Picked a lock with knife**

Booby-trapped jewelry with a cord

087 CEASE FIRE

**Made an arc welder with a wire, battery, and jumper cables**

088 SECOND CHANCE

Shot a syringe through rolled up paper

Blew up a gate lock

089 HALLOWEEN KNIGHTS

**Bypassed fingerprint reader with pool chalk and candle wax**

Bypassed rifle/motion detector booby-trap with apples, cabbage, garbage can lid, and tent cloth

**Repelled snakes with kerosene**

090 CHILDREN OF LIGHT

Broke down a door with a vise forcing a thick pipe through the door

Used a metal pole to slide down a rope

091 BLACK RHINO

None

092 THE TEN PERCENT SOLUTION

Broke through a metal door using a tube, an earring, and a light bulb

093 TWO TIMES TROUBLE

Used a camera lens as a magnifying glass

*Captured a fingerprint with tempura paint and tape*

**Escaped from a straitjacket while underwater**

094 THE MADONNA

Used barbells to roll stage

095 SERENITY

None

096 LIVE & LEARN

**Read burned paper with glycerol and water**

097 LOG JAM

**Used fire hose on thug**

098 THE TREASURE OF MANCO

None

099 JENNY'S CHANCE

Created a high-frequency noise with a wire and a microchip

## Appendix

---

### 100 DEEP COVER

Opened a submarine cover with a flare, oxygen and wire  
Pinned thugs with a raft  
Stopped boat by hooking it to the dock

### 101 THE LOST AMADEUS

*Opened lock with a hairpin*  
Activated fire extinguisher by putting a lit kerosene lamp in the trash  
**Cut rope binding him against a scroll saw blade**

### 102 HEARTS OF STEEL

Lifted a car with an electro-magnet

### 103 RUSH TO JUDGEMENT

**Picked a lock with his knife**  
**Made a soft drink dispenser shoot cans for distraction**  
Pushed a cart to knock bag lady down  
**Escaped from a pack of dogs using perfume and a mannequin**

### 104 PASSAGES

Opened a door with a fire hose and a boat axle  
Used baby powder to leave a message for Pete

## SEASON 6

### 105 TOUGH BOYS

**Picked a lock with his knife**  
Attempted to disarm a bomb with a lasso made from wire and an electrical cord while trapped in a net (Lucky MacGyver. The bomb was fake)

Escaped a locked garage by making a hook with two paint can handles and a lawn mower pull string then threaded it over the door to the other side

**Knocked out a thug on a balcony with a fire hose strung through a ladder**

106 HUMANITY

**Cracked a safe with a telephone**

*Tried to pick a lock with the wire mesh protecting a lamp*

Made a flare gun with a muffler, a stick, gasoline, and some cloth

107 THE GUN

Blew open a truck door with plastic explosive, a battery, and copper wire

108 TWENTY QUESTIONS

**Created a shadow decoy with a lamp, a small figurine, a table, and a dressing screen**

109 THE WALL

*Detected a laser beam from a hidden listening post with the smoke from a flare*

**Loosened ropes binding his hands with slimy goo from a toy store shelf**

110 LESSON IN EVIL

None

111 HARRY'S WILL

**Used knife to pick lock**

**Lifted a car with an inner tube**

## Appendix

---

### 112 MACGYVER'S WOMEN

#### **Used belt hook to untie ropes**

Used a horse to demolish a building

Emulated gunshots with pinecones, alcohol, and a stove

### 113 BITTER HARVEST

#### **Made a spectroscope with sunglasses, a lamp, and nail polish remover**

Escaped tank filling with poisonous gas by kicking off the lowest rung on a metal ladder, breathing through the hole where the rung had been attached, then cut rope binding his hand on the sharp edge where the rung had been.

Squirted wine from tank at a thug

### 114 THE VISITOR

#### **Picked lock with knife**

Faked a UFO landing with salt, fertilizer, and uranium

### 115 SQUEEZE PLAY

Figured out a thug's phone number by recording it and playing it back

### 116 JERICO GAMES

*Unlocked handcuffs with the pin on a badge*

#### **Escaped an incinerator with a metal rod**

### 117 THE WASTELAND

Made a paraglider with a backpack, a wind tunnel propeller, wire, and a nylon tent.

### 118 EYE OF OSIRIS

Used a mixture of sugar and water to harden an impression left in the sand so that a plastic mold could be made of the impression

### 119 HIGH CONTROL

#### **Used broken glass to cut ropes**

Sprayed ether with a window cleaner bottle to knock out a thug

Blew up a van with a homemade explosive (ingredients neither shown nor mentioned), a CO2 canister and a motorcycle

### 120 THERE BUT FOR THE GRACE

Made a booby-trap by filling a rubber glove with gas, setting a light bulb next to the glove, and then threw a lump of clay to break the light bulb. The light bulb explodes, opening the gas and igniting the gas.

### 121 BLIND FAITH

Shot rocks with a steam pressure hose

#### **Cut ropes with a metal grinder**

Jammed a door with a crowbar

Booby-trapped a door with an electrical generator

### 122 FAITH, HOPE AND CHARITY

Made a crutch from a hat rack

#### **Cut ropes binding him with a saw**

Made a wheelchair from a baby carriage

Booby-trapped a staircase by sawing through its wooden supports

## Appendix

---

*Disabled a thug with a mop and cayenne pepper*

*Tripped a thug by pulling a stair runner*

*Squirted chili at a thug with a vacuum cleaner*

### 123 STRICTLY BUSINESS

Escaped a trap by soldering tripwires to a rifle using the contents of a shotgun shell (flatten the buckshot and heated it with gunpowder).

### 124 TRAIL OF TEARS

Broke through a door with a T-bar and an air pressure release tube

Used a feather as a cotter pin to stop a bomb

### 125 HIND-SIGHT

None

## SEASON 7

### 126 HONEST ABE

Accessed the computer of a special helicopter with a flashlight

Blew up a door with alcohol and a fuse made from candle wax and cloth

Signaled a helicopter to fire its weapons with a razor and a mirror

### 127 THE HOOD

Escaped a torturer's rack with a stake and a skeleton hand

*Enhanced printing on burned matchbook with candle wax (Mac's explanation: the wax holds the ashes together, the ink had a metallic substance that wouldn't burn.)*

**Knocked an assassin off his scaffolding by threading a fire hose through it and attaching the fire hose to an elevator**

128 OBSESSED

Escaped from a missile launch pad using his boots and liquid nitrogen

**Created a diversion with window cleaner and a light bulb**

129 THE PROMETHEUS SYNDROME

Disarmed a bomb with a pin and a magnet

130 THE COLTONS

**Escaped being blown up by a bomb while being tied to a chair with a ruler, a cardboard tube, sulfuric acid and a dog. (Most absurd escape ever!)**

131 WALKING DEAD

Escaped from a coffin in the back of a truck using a rope and a bumpy road

Booby-trapped a tunnel with a brick, barrels, and some wire

132, 133 GOOD KNIGHT MACGYVER I & II

Made an antidote with egg whites and charcoal

Created an electrophoresis to isolate vanadium (a poison) with alcohol, wire, a candle, a zinc pot, a copper pot, and glass tubes.

**Made a fire extinguisher with baking soda, vinegar and a wine bag**

## Appendix

---

Escaped a firepit with the corkscrew on his knife  
Made a dog whistle with a copper tube and a piece of paper  
Made gooey lettering readable by burning it with gunpowder  
Shined a silver barrette with ammonia to make a mirror  
Escaped a dungeon with a homemade kite (silk, quills, clothe strips), gunpowder, a wine bag inflated with hydrogen produced from a combination of vitriol and zinc

### 134 DEADLY SILENTS

**Survived a 100 foot drop by poking his knife through a wallet and then insert the knife into a curtain and allowing the resistance to slow his descent**

Escaped a water tank by using his shoe and a hose to hook a rope ladder outside the tank  
Blew-out truck tires with a board full of upturned nails  
Used a fake movie building front to stop thugs

### 135 SPLIT DECISION

Made boxing training devices with automotive repair equipment

**Made a chill bag with sodium thiosulfate (a chemical fixer for photos) and water**

Attacked thugs with construction crane

### 136 GUNZ 'N BOYS

**Broke into shipping office by tearing off air conditioner**

**Blew open a door with a beer keg torpedo.**

**Picked the lock on handcuffs with the wire that surrounding the cork of a champagne bottle.**

### 137 OFF THE WALL

Melted the plastic tie-wraps binding his hands by pulling a heating element out of a space heater with a coat hanger and then turning on the space heater

Blew-up car by throwing a bomb down a construction chute into the path of a moving car

### 138 THE STRINGER

Escaped a cargo hold using a high pressure washer, 3000 PSI of water pressure, a steering wheel, and seat belts to make a water jet pack.

Created a smokescreen by lighting the powder inside a flare.

### 139 THE MOUNTAIN OF YOUTH

Escaped from a jail with an electric door with a scarf, a test tube, and access to the electric control box conveniently located inside the cell.

Used a ladder as a battering ram

### 140 LOST TREASURE OF ATLANTIS

Blew open a lock with butane

Picked handcuff lock with the firing pin of a gun

Blew off a door with a car, booster rockets, and a box of grenades

*Used knife to start a plane*

### 141 TRAIL TO DOOMSDAY

Made a gas mask from a wet rag coated with charcoal

Used belt as a pole grip to climb pole

Blocked door with screwdriver